

This article discusses the problems associated with handling of potent solids in development stage manufacture of Active Pharmaceutical Ingredients (APIs).

This article was developed from a seminar presented at the ISPE Amsterdam Conference in December 2001.

Reprinted from
PHARMACEUTICAL ENGINEERING®

The Official Journal of ISPE
July/August 2002 Vol. 21 No. 4

Process Containment Design for Development Facility - Part I

by Lewis Walker

Introduction

This article discusses the selection process for the appropriate technology required to provide containment of powders, ensure product security, and allow for practical materials handling. Detailed design considerations include the following four technologies:

1. Glove Box
2. Airflow Systems
3. Respiratory Protective Equipment
4. Fume Cupboards

Issues which are associated with the design of such systems include access, vision, ergonomics, cleanability, and transfer mechanisms. In terms of providing containment, there are four major issues to be considered:

1. Mechanical Handling - simply getting the material to or from the handling systems is required
2. Current Good Manufacturing Practice (cGMP) - protecting the material from contamination or physical change during the handling process
3. Control of Substances Hazardous to Health (COSHH) - protecting the workforce or other personnel from the effects of hazardous substances
4. Deciding on the level of containment required when the products for manufacture are unknown

Other issues such as dust explosion prevention, etc., are not considered in this article.

One of the aims of GMP is to provide product security and protection for the product, which is a pharmaceutical process raw material. Two principal factors, i.e., products of lower toxicity or products of high potency, determine the use of containment for pharmaceutical API.

In the case of products of lower toxicity, the major driving force in design is to prevent the possibility of product adulteration by minimizing the product contact with the free environ-

ment and strictly controlling the environment with which the product may come into contact. This has led to the development of "clean" technology.

For products of high potency or sensitizing materials, the major concern in design is to protect the workforce from the hazardous material. This has led to the use of barrier technology, airflow booths, fume cupboards, and other containment technology.

The latest regulations associated with cGMP and COSHH can cause the already complex design problems associated with mechanical handling to become extremely difficult to solve in a manner that allows efficient production to continue. Innovative design solutions, therefore, are required to provide practical solutions to the problems of containment and cleanliness.

In a development facility, a major issue is that materials are often being produced for use in toxicological trials and clinical trials stages 1, 2, and 3. Such materials are unlikely to have a defined Operation Exposure Limit (OEL), and the level of containment required for the process is required to be set by other means.

Basis of the Requirements for the Development of Containment Technology in the UK

The legislation, which drives the need for personnel protection, is given in HSE Guidance Note EH 44, and COSHH Regulations Approved Codes of Practice.

Containment of airborne dusts is required as these can cause harm in two ways:

- Damage to the respiratory system, e.g., pneumoconiosis, which is caused by the ingress of small inert dust particles into the respiratory areas of the lungs.
- Ingestion or other absorption of dangerous toxic substances, which may be carried in airborne dust. In addition, the length of exposure may be important as dermatological and respiratory sensitization may occur with time.

In the area of pharmaceutical containment, the

latter is often the greater cause for concern as the toxic effects of active pharmaceuticals are usually much more important than the mechanical damage caused by materials such as silica based dusts. The level of containment required is governed by the OEL of the dust as required by COSHH.

The OEL of pharmaceutical powders must be fixed by the means specified in COSHH; this may involve epidemiological toxicology studies (based on Phase II or III clinicals) or data from the literature. Where these are not available, conservative OEL estimates are usually the result.

The methods for determining the quantities of these types of dust which may be inhaled or respired by personnel are given in HSE Guidance Note EH42 "Monitoring Strategies for Toxic Substances" and in Methods for the Determination of Hazardous Substances (MDHS) 14 "General Methods for the Gravimetric Determination of Respirable and Total Inhalable Dust."

In general, the important airborne dust concentration is the "total inhalable dust" which is all the airborne dust in the operator-breathing zone, not "total respirable dust" which is all the dust of a size, which may cause mechanical damage to the lungs in the operator-breathing zone. The total inhalable dust concentration must be below the required OEL.

Regulatory Compliance

There are three generic areas for Regulatory Compliance:

- Environmental - EA
- Health and Safety - HSE
- Medicinal - FDA/MCA

The Environmental and Health and Safety areas will instigate design-setting release limits for the materials based on information received from the operator. The impact of the medicinal regulatory bodies will be in design to cGMP where specific limits for contamination will be set as part of the authorization/validation exercise.

The use of certain types of containment systems (e.g., fume cupboards) may result in the release of small concentrations of potent material via a simple vent stack, thus creating an environmental release and potential cross contamination under GMP. Vent and drain emissions, therefore, should be carefully considered under regulatory control principles and extract filtration should be applied, where appropriate.

Once Regulatory, Quality Assurance (QA), and Engineering Groups compliance/design have fixed the operational parameters to which the containment technology must be applied, then a system to validate the containment performance of the system must be developed.

In terms of dust control, the systems laid down in MDHS 14 (HSE) should be followed for measurement, but the monitoring program and test requirements should be the result of discussions including:

- Environmental Hygiene
- Production
- Design Engineers
- QA

The monitoring program should be a good reflection of operator exposure under all operating conditions.

HSE Guidance Note EH42 "Monitoring Strategies for Toxic Substances" is intended to advise employers about how they should conduct investigations into the nature, extent, and

control of exposure to substances hazardous to health which are present in the workplace.

Containment Device Types

Containment may be carried out in a number of ways. The aim of this section is to discuss the types of containment, which may be used in the handling of small quantities of potent solids in pilot scale process equipment.

There are, basically, four available containment technologies to consider:

- Respiratory Protective Equipment (airsuits, half suits, air-fed helmets, dust masks, etc.)
- Airflow Techniques
- Mechanical Isolators (glove boxes and alpha beta connections)
- Fume Cupboards

Respiratory Protective Equipment (RPE)

Air Supplied Suit

The use of airsuits is best defined in HS(G) 53 RPE: *A Practical Guide for Users*, and by good working practices defined by the operating company procedures. However, it is clear from the spirit of COSHH that airsuits should generally not be used unless all other reasonable means of dust control have been employed to achieve a suitably low contamination level.

EH44 states "RPE should not be used as a substitute for dust control."

Protection levels provided by airsuits have been quoted by vendors (depending on suit type, e.g., half suit or full suit) at 10000:1 (according to British Standards). Operating companies, however, may choose to use lower allowable protection ratios, for example, 1000:1 or 500:1. This ratio is affected by the behavior of the toxic material, and how easily the particular material may be cleaned from the suit during decontamination.

The problems associated with decontamination are influenced by zip design, operating procedures, cleaning procedures, the type of shower or other cleaning system, and the interface with the changing area and airlocks, etc. Airsuits can make bulk handling difficult if manual work is involved or operations requiring high manual dexterity are required, e.g., the use of glove boxes or dispensing fine quantities. Also, there are recognized health hazards associated with the sharing of air suits, e.g., bacterial and viral transfer and other dermatological problems.

There are other problems associated with supplying air to the RPE in various processing/changing areas or by mobile devices.

Other Respiratory Protective Equipment

Other equipment types include:

- Air-Fed Half Suits
- Air-Fed Helmets
- Dust Masks

The general comments, which apply to airsuits, also apply to these devices. They should not be used as first line protection devices. The use of these devices should be as a back up to other

containment systems. Any decontamination or disposal systems required to operate these devices also should be carefully considered.

Airflow Techniques

Downflow Booths

These booths use air in laminar downflow to provide containment in a specific area of the booth. By the use of suitable operating practices, some vendors will give a guaranteed level of containment to $20\mu\text{g}/\text{m}^3$ total inhalable dust in the operator-breathing zone.

Small deviations in the laminar flow region (e.g., caused by the presence of the operator) can have major effects on the levels of dust, which may be present in the operator-breathing zone.

This means that this technique is not applicable where short-term excursions over the OEL are not allowable, or where the operator may commonly disrupt the protective laminar airflow region. This containment method, however, does provide a flexible operator-friendly method of containment because the operator is not bound to any restrictive equipment, such as airhoses. However, it should be stressed that the operator is restricted to carrying out the operation in the laminar flow region of the booth.

Laminar Flow Booths

These booths may be either horizontal flow, to give a suitable face velocity, or general downflow booths. Both types of booths provide a general laminar flow across the whole booth rather than at a specific area of operator interface. The levels of containment achieved by these booths are dependent on the operation being carried out. Airflow protection suffers a fundamental problem when the operator may break up the laminar flow pattern.

General laminar flow booths also have a problem in that the dust generated may be distributed around the whole of the surface of the booth (or room) as airflows are disrupted or as high air velocities entrain surface layer dust and carry it around in a turbulent manner.

Operator activity may cause considerable variation in the instantaneous airborne dust level. This must be taken into account if this technique is proposed for handling materials for which short-term excursions above the OEL are not permitted.

Local Extract Ventilation (LEV)

This system is the specific application of LEV technology to a specific dust generation problem where nozzles are placed very close to the dust generation point. This is not a description of a simple LEV hood placed in the general vicinity of a dust source.

LEV allows high air velocities at the point of dust generation; these high velocities provide very high efficiencies for particle capture. However, the capture velocity decreases exponentially with distance from the LEV source. Therefore, to maintain a high level of containment, the LEV source must be close to the point of dust generation for effective containment. This means that very high capture rates may be achieved depending on the complexity of the LEV and adoption of restrictive practices to prevent operations outside the boundaries protected by the LEV.

LEV may not lead to very high rates of total airflow, and general extract ventilation or booths may be required in addition to the LEV for overall ventilation purposes. Very high

levels of containment have been claimed using these techniques. Design is system dependent, however, and the use of complex multi-extract point systems may provide excellent levels of protection over a wide operation area.

For applications where the equipment under operation cannot be placed in a suitable booth or design, e.g., to provide complete containment, this may be an applicable airflow technique.

Other Considerations

In general the use of airflow techniques may give rise to large air demands. If solvents are present, recirculatory systems should not be used as this can lead to solvent vapor build up. This may place high demands on the general HVAC system, which may be trying to maintain a balanced pressure and flow regime within the clean solids handling area. Where pressure balancing problems, high airflow rates, inconsistent containment, and other miscellaneous problems occur, the design may be driven toward mechanical isolation type devices.

The cleaning of open booths also can present a problem if solvents are required in significant quantities. Design and operating procedures must consider the hazards of ignition and solvent vapor or inert gas inhalation.

Where vent systems involve dust capture onto extract filters, safe change of filters, and duct cleaning may be an issue. Where extract systems are multi-product, cross-contamination issues must be considered.

Mechanical Isolation Devices

Glove Boxes

These are often referred to as primary protection devices, or isolators, and are often unique custom design devices.

The design may be hard or "soft" (a sort of glove bag) and they use a clean and dirty port system through which material is moved, often through special entry/exit ports fixed in the side of the box, or through bag in bag out type systems. The type of container (e.g., keg or bag) and the weight of the container may require mechanical assistance for maneuvering the material to a position where the required activity (e.g., tipping, loose weighing) may be carried out.

As the size and number of containers being handled increases so do the problems of bulk handling and system management. Keg tippers and other mechanical conveying equipment are often required to handle kegs. Thus, large scale glove boxes become difficult to operate satisfactorily, especially if strenuous manual effort is required to pull more kegs or liners out of kegs, etc. Similarly, large numbers of small containers may require arduous operation if ergonomic design is inappropriate.

Glove boxes potentially provide a very high degree of containment. However, the practical usage problems are often large as the systems may be difficult to operate in the way that the operator would prefer.

Cleaning the glove box is often difficult, especially if solvents are required to dissolve any stray powders. Clean-in-place systems or cleaning access to the glove box are not straightforward design problems. It is vital to operate and maintain precisely according to the design intent and the agreed operating procedure. Additionally, design effort must go into the transfer of the hazardous material both in and out of the box, containment of waste materials (e.g., used liners, used kegs, wash streams), and cleaning as these activities may prove to be more arduous than the design for the routine operation

within the glove box.

Pressure and/or vacuum protection may be required if the glove box is directly coupled to a pressure vessel. The gloves may represent a weak point in the structure and therefore their performance should be closely monitored.

Pressure regimes within the glove box are important. Specific problems for the designer include ventilation versus fail-safe requirements and the control of flow at all times.

Mechanical Handling Devices

Keg Tippers

Pharmaceutical intermediate dry products are often stored or collected in kegs, which are double lined with plastic bags for containment and product protection. The use of these devices is common and a simple operation. However, in terms of containment, there is an issue whether these devices are the best available technology for containment. Since most bulk pharmaceutical plants use this method of solid handling, it is worth discussing how these can be used in association with the other equipment discussed in this article.

Kegs come in various sizes; 25 kg is the maximum that an operator is allowed to manually carry without mechanical assistance. Manual repeated charging of 25 kg kegs is an arduous task. If this is made more difficult by protective devices, e.g., glove box, wearing an airtight suit, working within the confines of a downflow booth, then mechanical assistance may be required.

If the double liners are to be removed inside a glove box, then mechanical assistance may be required even for small kegs as the operator may have to work in positions, which are suitable for lifting loads, i.e., it is difficult to lift and pull a keg or liner at arms length through the typical ports of a glove box.

There are many mechanical handling devices on the market. When choosing or designing such a device, significant effort is required to specify the duty that the device is to fulfill. The problems of cleaning and maintenance must be considered, especially if the device is to be in a cleanroom or within a glove box. The size of the tipper may affect the size or operation of the containment device. Therefore, the mechanical handling system must be an integral part of the design of any containment system for bulk potent powder handling.

Intermediate Bulk Containers (IBCs)

IBCs may be solid or flexible (FIBCs). These devices are often larger than kegs and may approximate to 1.5 tons in the pharmaceutical industry. They may contain liners in the same way that kegs have liner systems.

If the system is a traditional IBC, e.g., stainless steel construction, and generally operates a charge bin and a filling station, it requires the type of containment devices discussed earlier in this article.

FIBCs are a slightly different concept as they are basically big bags. Therefore, the discharging and filling of these systems often require proprietary devices to facilitate this operation. They are generally used for bulk materials, which tend to have lower containment requirements than small amounts of active pharmaceuticals, although there is no theoretical limit to their potential levels of containment.

Loading and discharging containment would be by the type of equipment described under Containment Devices Types,

although alpha/beta ports and other high-level containment docking systems are now available for this type of operation.

Containment Available

The levels of containment quoted in this article are the general levels which in the author's experience have been quoted by designers or achieved in practice.

When a system is designed, careful consideration must be given to all operations and the potential exposure:

- when the operator or equipment is not in the correct position
- during cleaning operations
- during docking/undocking of devices
- during entry/exit through ports
- on disposal of keg/liners/other powder contacted materials
- during decontamination operations of the equipment or operator's protective clothing
- during dispensing operations
- vents and drain discharges
- containment room boundaries including piping penetrations

It may be that these operations prove to be more arduous than the "normal" operation.

Once the equipment design has been chosen, the system must be rigorously tested before construction as far as possible (e.g., by the use of "mock-ups," computer modeling), and during operation.

The Methods for the Determination of Hazardous Substances (MDHS) by the HSE should be followed when monitoring the contamination levels of dust in the operator-breathing zone. MDHS 14 sets out general methods of monitoring dust levels.

The author's experience is that the levels of protection expected in design are often not achieved in later operation.

Part Two of the article will focus on a case study which discusses the key containment features for the design of a multi-purpose laboratory for the manufacture of kilo scale quantities of primary pharmaceutical products for use in clinical trials and will be printed in the September/October issue of **Pharmaceutical Engineering**.

Bulk Handling Problems

Handling large quantities of solids can be an arduous process. If the containment devices make the practical difficulties encountered by the operator large, then there is a risk that the appropriate operating procedures may not be followed. Therefore, the practicality of use must be considered in design of a containment system.

If the design of the containment system leads the operator to take short cuts then the system is inherently flawed as a containment system.

About the Author

Lewis Walker is a Technology Manager - Pharmaceuticals for Jacobs Engineering.

Jacobs Engineering Ltd., Jacobs Engineering, Bird Hall Lane, Stockport, Cheshire SK3 0XF, United Kingdom. 

This article presents three major elements of central cooling systems for batch manufacturing plants: chilling, distribution, and capacitance. The role of capacitance in system performance is emphasized. Recommended features and practices for all three elements are presented.

Reprinted from
PHARMACEUTICAL ENGINEERING®

The Official Journal of ISPE
July/August 2002 Vol. 21 No. 4

Capacitance: Key Design Consideration for Refrigerated Central Cooling Systems for Batch Process Plants

by Peter N. Notwick, Jr., PE

Pharmaceutical plants manufacturing chemical or biological Active Pharmaceutical Ingredients (APIs) routinely require heating and cooling of batch operations such as chemical reactions and fermentations. The cooling temperatures required are usually below that which can be achieved with cooling tower water and are most often below room temperature. This necessitates the use of refrigerated cooling media that are nearly always generated by mechanical refrigeration plants, often referred to as “chillers.” The requirement for low temperature coolant is usually addressed by providing a central, plant-wide generating and distribution system servicing all of the process users.

It is an overriding principle that mechanical refrigeration equipment has only limited ability to cope with widely or rapidly varying heat loads. It is also a fact that multiple batch process users impose just that type of load on the supplying system. The inherent conflict between the requirements of the process and the limitations of the generator provide the challenge to the designer of central plant process cooling systems. Capacitance is the most effective tool for meeting this challenge.

Capacitance - The Critical Element

Any central cooling system consists of two main elements: generation and distribution. In this case, the generator is the chiller and the distribution system consists of the tank, pumps, and pipes that deliver the coolant (also known as the heat transfer fluid or HTF) to the users and return it after use for recooling. If the cooling duty is more or less constant, these components

are all that is required. Chilled water systems that serve building air conditioning requirements are examples of two element systems.

However, batch process cooling requires a third element: a buffer between the varying loads imposed by the process and steady state environment required by the chiller - *Figure 1*.

This buffer can be referred to as “surge,” “equalization,” “holdup,” “flywheel,” or “capacitance.” It can be introduced into a system in two forms: a significant storage volume of HTF equal to several minutes of circulating flow and the dilution effect of the circulating flow itself. In the first type, by interposing a storage volume between the chiller and the distribution network, a temperature/time integration effect is achieved that mitigates the peaks or spikes in returning or outgoing HTF temperature. In the second form, a circulating volume large enough to supply all users simultaneously will provide a dilution effect for high return temperatures from a few users because of the low heat load or idleness of the rest. Both forms are essential to a well-designed system.

For batch process cooling systems, capacitance is the most critical element. Insufficient capacitance can cause an apparently oversized chiller to fail to provide sufficiently cold HTF to the process. This occurs because, although the cooling capacity is available, the chiller cannot respond rapidly enough to meet sudden peak load. Capacitance attenuates and spreads out the peaks, allowing time for the chiller to respond. It can therefore be asserted that the cause of inadequate overall system performance can frequently be traced to a poor understanding of the role and requirements of capacitance.

What follows is a consideration of the design parameters and attributes of each of the three elements of central cooling systems in batch process service. This article will discuss systems that:

Figure 1. Storage volume (“capacitance”) situated between the chiller and the distribution system buffers interactions between the two.

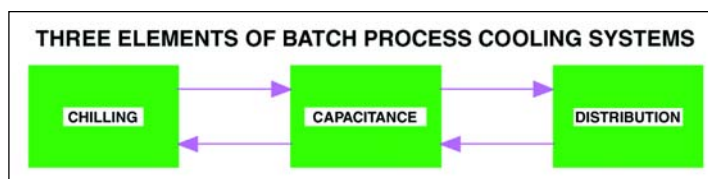

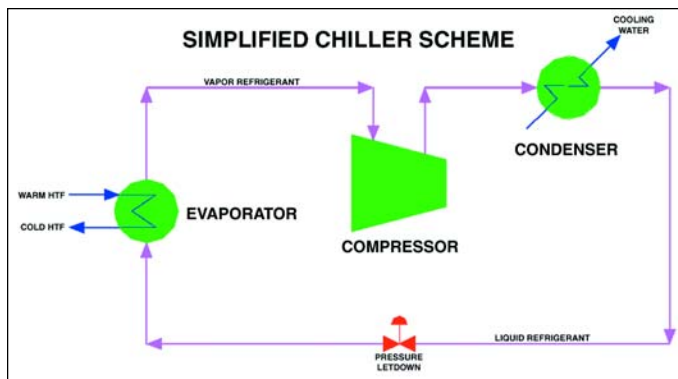

Figure 2. A simplified chiller schematic showing the major elements.

- use only mechanical (as opposed to absorption or cryogenic liquid vaporization) refrigeration
- supply a single cooling fluid (HTF) to process users
- generate and distribute HTF at a single temperature
- serve multiple, variable load users

The following ancillary topics will not be considered:

- nature and design of the process users
- local conditioning devices or systems feeding off the central cooling system, such as tempering loops
- HTF selection
- refrigerant selection
- heat load computation or assessment
- instrumentation or control schemes

Chillers

The refrigeration plant or “chiller” is an integrated package of equipment, piping, and controls provided by a specialty manufacturer. Three major unit operations constitute the refrigeration cycle: evaporation, compression, and condensation. This scheme is illustrated in Figure 2. A simplified description of the cycle is as follows:

Warm HTF returned from process users is passed through the tube side of the evaporator (also called the “cooler” or “chiller”). The heat provided by the HTF causes the pool of refrigerant on the shell side to boil at a temperature that corresponds to the pressure imposed on that side of the evaporator. This pressure is controlled based on the required supply temperature of HTF to the process users. The vapor produced in the evaporator is drawn into the suction of the compressor where the pressure is raised to a level that will permit condensation against a convenient coolant (ambient air or cooling tower water). The compressed vapor is condensed and subcooled in the condenser. The pressure on the refrigerant is then abruptly reduced to evaporator operating pressure by let down through a throttling valve. The subcooled refrigerant then flows to the evaporator, completing the cycle.

Chiller packages for process service in chemical and biological API plants typically have a cooling capacity less than 1,000 tons (3,500 kW). In biological operations where the process fluids are aqueous based, the HTF supply is maintained above the freezing point of water, typically 4.5 to 7°C (40 to 45°F). In solvent-based chemical operations, temperatures can range much lower. HTF supply temperatures of -20 to -25°C (-4 to -13°F) are typical, but temperatures as low as -70°C (-93°F) are not uncommon. This has important implications for electric power consumption. For instance, a ton (3.5 kW) of refrigera-

tion delivered at 5°C requires 0.9 HP (0.67 kW), while the same unit of cooling at -20°C requires 2.8 HP (2.1 kW).¹

Compressor

The heart of the chiller is the compressor. It provides the energy to accomplish the seeming thermodynamic contradiction of causing heat to flow from a region of lower temperature (the HTF stream) to one of higher temperature (the ambient environment).

Although there are several types of compressors, process chillers nearly always utilize the oil-injected screw type. The principal reason for this is that screw compressors have the best turn down characteristics. That is, they are the most stable and efficient at loads less than their design capacity (even down to 10%) than any other type. Moreover, they can run at reduced capacity indefinitely with no ill effects. This is important because chillers in batch process service spend most of their operating time in low-load condition.²

The turndown capability of screw compressors complements the effect of capacitance. The compressor can react to slowly varying loads and sustain stable operation at almost any duty. The buffer shields the compressor from sudden changes in load that may exceed the compressor’s ability to react. Working together they promote more precise control of the HTF temperature supplied to the process.

Condenser

The refrigerant condenser can be either water cooled or air-cooled. In most climates, water-cooling has a distinct advantage from the standpoint of electrical energy consumption. The underlying principle is that the temperature of cooling tower water depends on how closely it can approach the ambient wet bulb temperature. Air-cooled condensers on the other hand are limited by the ambient dry bulb temperature. Since in temperate climates the summer design wet bulb temperature is typically 7 to 14°C below the design dry bulb temperature, cooling water can condense refrigerant at lower pressures than air can. Therefore, for a given set of operating requirements, an air-cooled system will require a higher compressor discharge pressure, and hence, compression ratio. This means that the compressor must do more compression work. Typically, the penalty for air-cooling is on the order of 30 to 40% higher power consumption compared with water-cooling.

An alternative that may be considered if water is not available from a central cooling tower system is to provide an evaporative condenser. This is in effect a dedicated cooling tower for the chiller. The refrigerant vapor condenses inside coils. On the outside, fans draw ambient air through the unit while falling water cascades over and evaporates on the outside surface of the coils in a cross flow or (preferably) parallel flow pattern. Among the advantages of dedicated evaporative coolers is that they can reduce compressor power requirements compared with centralized tower water supplies. These savings can be achieved by tailoring the condenser operation so that the refrigerant can be condensed at a temperature that more closely approaches the ambient air wet bulb temperature. Another advantage is that evaporative condensers avoid the investment in and operating cost of cooling water circulation. However, this solution must be applied with caution. Unless a source of soft makeup water is available or high water circulation and blowdown rates are maintained, this type of cooler can be a source of significant maintenance headaches because of the tendency of the coils to scale.^{3,4}

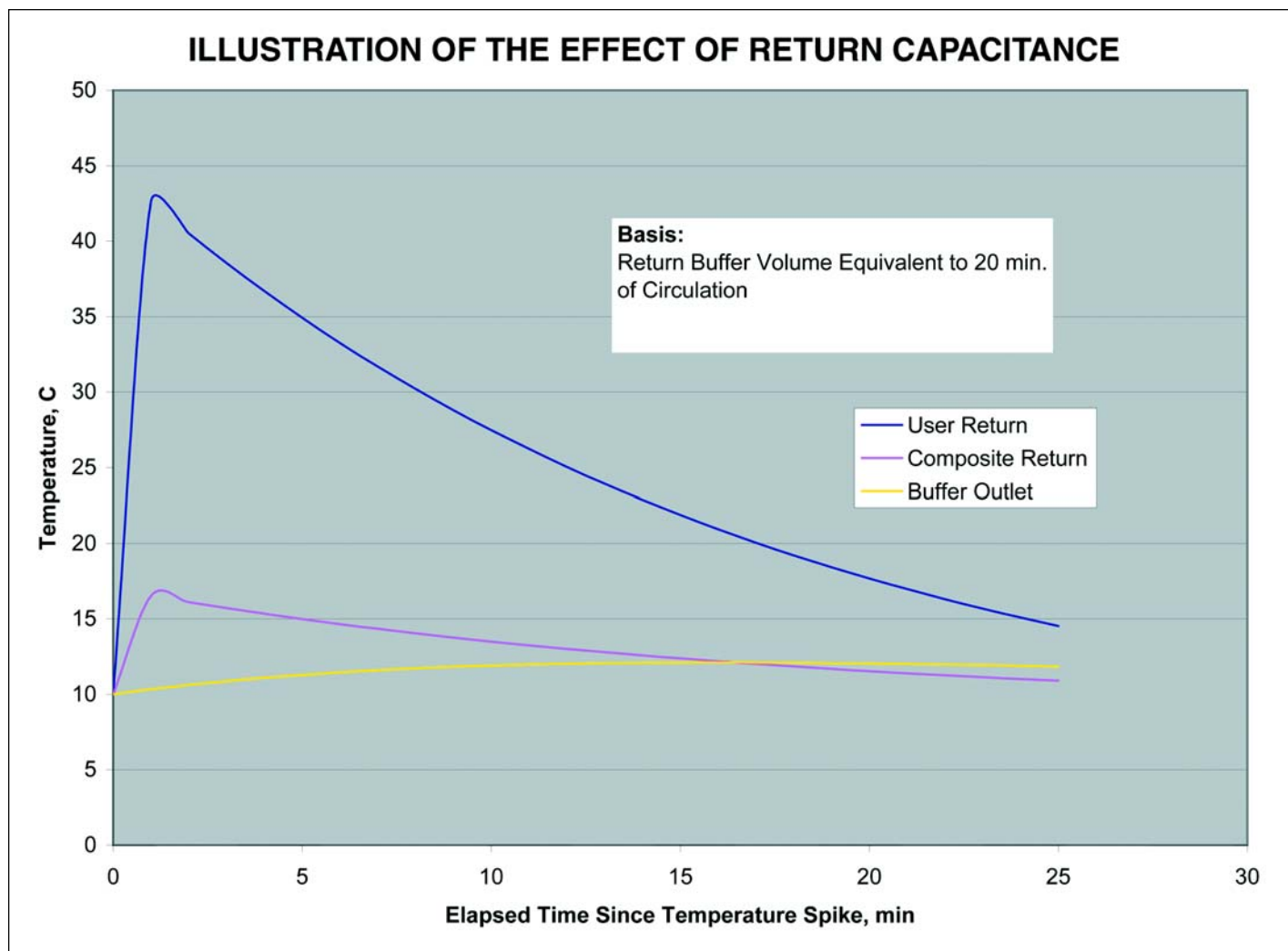

Figure 3. Simulation of a spike of hot return fluid representing 20% of the distribution flow with a return buffer volume equivalent to 20 minutes' total flow.

Evaporator

The operation of the evaporator can be in one of two modes: flooded or variable level. Flooded operation is preferred because it is more stable and able to respond more readily to changes in refrigeration load. This responsiveness derives from the fact that there is capacitance built into the refrigerant circuit itself. In operation, a stable liquid refrigerant level is maintained in the evaporator by a level control loop with a surge vessel located upstream to cope with the swings in liquid volume. However, these provisions coupled with the need for a substantially larger refrigerant charge result in a higher initial cost.

In the variable level mode, the fluctuations in liquid volume in the evaporator cause the effective heat transfer surface to vary as tubes are alternately submerged and uncovered. This scheme places more reliance on the compressor controls to respond to varying loads that it will see as fluctuations in vapor flow rates from the evaporator. This process is naturally more sluggish and can result in wider excursions in the HTF supply temperature to the process.

Reliability

The function of a process chiller is usually considered crucial to production. Interruption of cooling can result in the loss of valuable product. Consequentially, the reliability of cold HTF

supplies cannot be compromised. Since even the most robust and well-maintained chillers cannot be considered 100% reliable, redundant units are usually installed. The strategy for providing redundancy is highly subjective and case-specific. Two common schemes are: two 100% design capacity units, or three 50 or 60% units. Where it is determined that full design load is not critical because some operations can be shut down in case of chiller loss, a generation system of two 75% units might be considered. In general, reliability is improved by the installation of large total capacity distributed among a large number of units. However, the cost of following this strategy increases rapidly with the number of units (e.g., six 25% units will be more reliable than two 75% or 100% units but will cost more on an installed basis).

Nevertheless, simply having a number of chillers representing plenty of excess capacity does not guarantee reliable coolant supply. In order to be able to respond when called upon, each unit must be exercised to maintain its readiness. This is accomplished by the use of lead/lag controls. This type of control manages the load to maximize the utilization of all units. For instance, the controller may distribute a demand of 50% of design capacity by loading two 100% chillers to 25% each. If the demand increases slightly, it may add load to the "lead" unit while allowing the "lag" chiller to remain at the lower loading. If demand were to drop below a value that

cannot be readily distributed between the two units, it may shut down the “lag” machine. Periodically it will reassign lead and lag roles between the chillers. While this strategy is straightforward for the example given, the complexity of the control system and the possibilities for failure increase rapidly as more units are added. This then is another consideration to be taken into account when developing a redundancy strategy.

The point to be reiterated about chillers is that regardless of how favorable their turndown characteristics are, they are basically steady state machines. They are specified to deliver a certain amount of cooling (temperature reduction, often 7 to 10°C) to an HTF stream with certain characteristics (properties) flowing at a given rate. They have a limited tolerance for large or rapid inlet temperature and HTF flow excursions. Subjecting them to these kinds of disturbances can result in consequences ranging from out-of-spec HTF process supply temperatures to compressor shutdowns. Preventing these occurrences is the function of capacitance.

The Case for Capacitance

HTF return temperature spikes are routine, planned events. For example, a typical case might occur in a biologics plant when a group of buffer vessels or bioreactors are subjected to wet tank sterilization simultaneously.

Figure 3 graphically illustrates such an episode that can be described as follows:

At the conclusion of the sterilization cycle, the vessels must be cooled down from steam temperature (over 120°C) to operating temperature (20 to 40°C) by cold (5°C) HTF flowing through the vessel jackets. The initial return temperature of the HTF from the hot users could be over 40°C. If this represents 20% of the circulated volume and all of the other users are below design load conditions (for example, 10°C return temperature compared with 12°C design), the net return temperature to the chiller system would be 16 to 17°C. In this way, the circulating volume attenuates the effect of the high-imposed load by dilution. As beneficial as the dilution effect seems, if the design of the chiller calls for this temperature to be 12°C, an out-of-design condition will be imposed on the chiller. The chiller’s controls will try to respond by ramping the compressor to maximum output, but the response may not be fast enough or the chiller’s capacity might not be great enough to prevent the output temperature from rising out of specification.

If, however, a buffer volume the equivalent of 20 minutes’ circulation is provided upstream of the chiller whose temperature prior to the arrival of this spike is below (10°C) the design return temperature (12°C), the HTF temperature inlet to the evaporator will not exceed 12°C for the entire episode. This prevents the chiller’s having to cope with an excursion from design conditions, and therefore prevents impacting the HTF supply temperature.

As a practical matter, however, 20 minutes of surge may be difficult to provide. A large tank occupies significant valuable building space and adds capital cost to the project. Sometimes this forces designers to provide less surge volume. In doing so, they choose either to depend on the chiller to absorb the attenuated spike in duty or to accept an excursion in HTF supply temperature to the process. This latter consequence can be acceptable because of the tolerance usually specified for the HTF supply temperature (e.g., 5°C +/-3°C).

Revisiting the example just considered using a 10-minute return surge volume reveals that the chiller inlet temperature from the buffer tank will rise above 13°C. However, since the

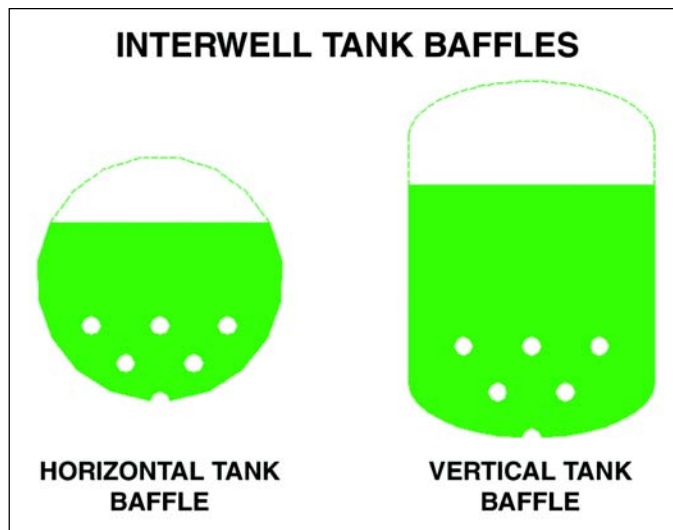

Figure 4. Hot/cold well partition baffle examples.

capacitance in the system has caused this excursion to come about gradually (over a period of about 10 minutes), the chiller should be able to absorb the excursion and still produce cold HTF within specification.

It can be shown by a similar analysis that capacitance on the supply side is also advantageous because it buffers the process users from excursions in chiller output temperature. However, supply side capacitance is much less important to maintaining overall system stability than return side capacitance. For example, when the model developed for the illustration above was tested for equal (10-minute) buffer volumes on the supply and return sides, it was found that while the return side had a maximum attenuation effect of about 6°C, the supply side showed only a 0.6°C effect.

Nevertheless, supply side surge is frequently provided, but its function is more often to provide stable suction for cold HTF distribution pumps. As such, its volume requirement tends to be lower than for the return side. Indeed, a 1:2 supply/return volume split is a typical practice among some utility system design specialists.

Capacitance Volume Determination

The above example can be taken as an illustration of the method for sizing a surge volume. The calculations that must be performed are finite difference of temperatures with respect to time (usually in increments of one minute). Electronic spreadsheets are the tools commonly used for the analysis. With knowledge of the sizes (i.e., flow demands and heat loads) of the users and the types of operations they are engaged in, a model can be constructed that will allow the designer to test various combinations of circulation rate, spike loads, and surge volumes. Agreement with the end-users concerning the validity of the assumptions and concurrence with project management on the cost consequences of the design complete the process.

Note that this method is applicable to all types of batch plants. Chemical and biological based API plants differ only in degree. Chemical plants tend to have a greater variety of loads and more sustained individual loads than biologics operations for the same volumetric scale plant. This usually translates into larger circulation rates and surge volumes for chemical operations.

Capacitance Design

In properly designed systems, the rate of HTF circulation through the chiller is specified to be equal to the distribution rate to users. In theory, this practice maintains a balance between the supply and return side surge volumes. However, in practice volumetric imbalances develop in the normal dynamics of the system. When these small dislocations accumulate to a noticeable degree, it is necessary to redistribute HTF between the two surge volumes.

The ideal method for equalizing volumes is to connect the two reservoirs to allow continuous static balancing. However, this is difficult to accomplish in two surge tanks separated by some distance. In order to achieve the effect, the system must be able to transfer HTF at a rate as high as the circulation rate with only the driving force of a few inches of differential height between the two vessels. This dictates the need for very large piping.

To avoid this problem, the typical surge design encloses both volumes in a two chamber vessel whose compartments are designated the hot (return) well and the cold (supply) well. Volume equalization is achieved by providing perforations in the separating wall or baffle (preferably located in the lower one-third of the vessel cross section) large enough to allow rapid exchange of volume in the case of an imbalance (See Figure 4 for typical baffle layouts). This arrangement, while advantageous for the stated purpose, accepts some penalty in thermal efficiency due to the intermixing of hot and cold fluid and thermal conduction through the dividing wall.

Two other design features that should be incorporated into the baffle are:

- A less than the full height baffle - this is to avoid overflowing a compartment. The top window is sized as an overflow weir to handle a volumetric flow rate at least equal to the circulation rate.
- A substantial size weep hole at the lowest point of the baffle - this will permit full drainage of both compartments from either side of the tank. The large size will forestall pluggage by sludge that can accumulate in these tanks.

It should be emphasized that in order to obtain the buffering effect, the inlets and outlets of the tank must be arranged to achieve flow-through pattern. This typically means inlets are at the top of the tank and outlets at the bottom. Configuring this tank as an expansion vessel with only one, two-way inlet/outlet connection will prevent the buffering effect. However, a less effective, but still viable flow-through pattern, can be established in this type of tank. These two arrangements are illustrated in Figure 5.

The surge vessel itself can be either horizontal or vertical. A horizontal tank mounted on saddles is more expensive than a flat-bottom, dished top vertical tank, but it has several advantages that should be considered. For instance:

- Because the horizontal tank stands up off the floor, it maintains a more uniform suction pressure for the pumps.
- In order to be supported above the floor, the horizontal tank must have thicker shell plate. This makes for a more robust, longer-lived vessel. It also may be pressure rated for less additional cost.

- The horizontal tank is more easily drained, flushed, and cleaned.
- The horizontal tank is more conveniently divided into dissimilar size compartments.

Besides providing capacitance, the surge vessel serves three other functions: coping with thermal expansion, maintaining surge for pump suction requirements, and providing drainage volume. This last function addresses the fact that when the distribution system is shut down, the HTF inventory tends to drain to the lowest point of the system. Check valves only slow this process. Isolation valves on main headers and branches that could be used to prevent backflow are seldom provided. Therefore, in addition to its temperature equalization function, the buffer tank should retain sufficient freeboard to accommodate the HTF volume contained in the distribution headers and users.

HTF Distribution

Starting with the assumption that the distribution pumps and piping have been designed with sufficient capacity to meet all of the anticipated demand scenarios, what remains for the designer is to ensure that sufficiently cold HTF reaches every user as needed. The principles that should guide the design of a distribution system can be simply stated:

- keep it cold
- keep it moving
- keep it equally available

In practice, the header system arrangement must avoid the possibility that the shut off of a user or group of users will interrupt the circulation of HTF in some portion of the distribution system. Trapped HTF will gradually warm up. When a user in the stagnant zone comes on line, it will initially receive warm HTF that can be deleterious to the process and violate the manufacturing protocols that govern correct production.

It follows that the design of the distribution system should not depend on users having to be on-line to maintain circulation. At the same time, no user should be starved for coolant flow regardless of how much demand is being imposed on its particular circuit. Finally, it should be possible to start up the cooling system after a protracted outage in which the HTF has warmed up and be able to cool it down to the operating temperature without exposing any of the production equipment to the elevated temperature.

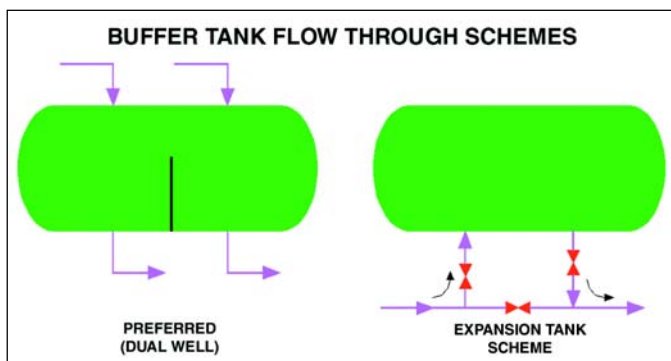

Figure 5. In order to achieve the capacitance effect, HTF must flow into and mix with the buffer volume.

Supply/Return Bypasses

Keeping the system cold in large measure depends on maintaining essentially full flow through the headers at all times. This is accomplished by equipping the ends of main and branch headers with bypasses from the supply to the return header, in effect making the distribution system into a loop. These bypasses should always have flow through them regardless of how many users are making demands on the system. In order to accomplish this reliably, end-of-header pressure controls should be provided (See Figure 6 for examples). The bypass line and control should be sized and set so that sufficient pressure is maintained in the supply header to provide the driving force for full flow through any given user. However, there are occasions when this ideal arrangement cannot be realized. Examples are small systems such as those provided for pilot plants or small branch headers. An alternative to using a control valve to maintain bypass flow is equipping the distribution pumps with variable speed drives. On a first cost basis, this can be a good deal more expensive than a control valve. However, with very large pumps (e.g., greater than 100 BHP or 75 kW), the long-term energy savings can make this an economical choice.

Multi-Loop Distribution

Where users are located on multiple floors or in multiple wings of a building, competition for flow frequently develops between them, raising the possibility of starving some groups of users. Manual balancing valves located at header junctions are a common solution to this problem. Although this type of solution can be effective where demands in all of the loops are essentially constant, the varying demands of batch process systems do not lend themselves to this simple approach. Self-contained, active flow control devices such as “circuit setter” valves or three mode valves (one device serving shut off, non-return, and flow control functions) typically used in HVAC chilled water distribution systems are a better solution. After a one-time adjustment, they will control flow entering a loop, responding to varying supply pressures. It should be noted that these types of valves need not be installed on all circuits of a distribution system. If provided only in more hydraulically favored circuits to limit flow, supplies will become more available to other loops.

Header Sizing

When certain users are consistently starved for coolant in an apparently amply sized system, the culprit can usually be found to be improper header sizing. If header velocities and pressure drops are too high, a localized condition at a given user take off point can develop in which there is insufficient pressure to drive the full required flow of HTF through the user. In some circumstances, the starved user is the first on the circuit, in other conditions, the last. While it is difficult to anticipate all demand scenarios and nearly impossible to calculate them, there are a few principles that can guide the designer to a header system design that will perform properly for all eventualities.

A classic model⁵ used for dead-ended, drilled-hole distributors also can be employed for the present purposes. The basic principle of this method states that if the calculated pressure drop of the supply header under full design flow conditions is less than 10% of the pressure drop experienced through a typical user, maldistribution can be substantially avoided. This model is somewhat conservative since the end of header mate the switchover so that the pump can be cycled in and out of service. When the complexity and cost of operating and maintaining this pumping system configuration are considered, the conclusion is obvious: don't do it.

Joints and Seals

Many organic and silicone HTFs have properties (low surface tension and viscosity) that cause them to become “seeking” (tending to leak out of the system through seals and gaskets) at high temperatures (above 150°C). Some of these fluids exhibit a degree of toxicity, flammability, and odor hazards that is unacceptable in most settings, but are particularly objectionable in GMP manufacturing spaces. Consequently, in order to forestall leaks, designers have adopted the practice of using 300 lb. flanges, metallic gaskets, bellows valve seals, sealless pumps, etc. in distribution systems that handle these fluids. However, at low temperatures such as those considered here, these fluids are much better behaved. It is therefore possible to avoid including these special, costly features if the designer can ensure that the distribution system will always remain at or below ambient temperatures. In any event, the

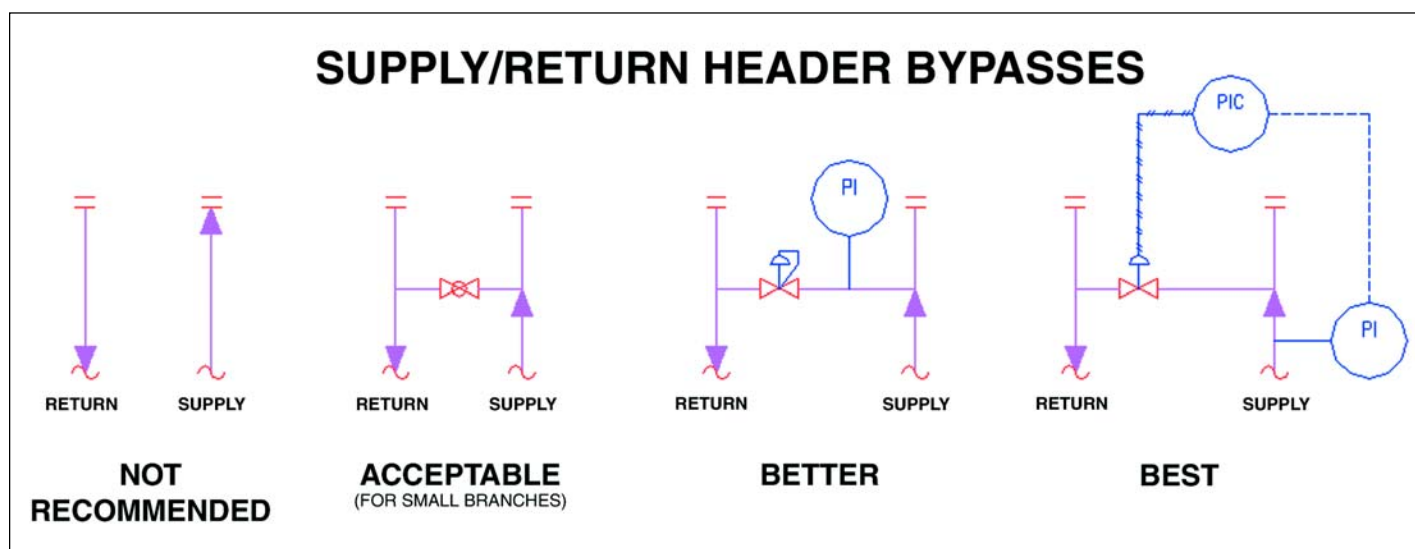

Figure 6. Examples of supply/return bypass header end configurations.

HTF manufacturer's recommendations should be solicited rather than simply assuming that these special containment features are required.

Materials of Construction

Notwithstanding the preferences and requirements of the facility and owner's practices, carbon steel, bronze, and copper are acceptable materials of construction for the distribution system for operating temperatures above -29°C (-20°F) for nearly all HTFs. However, below that temperature, the ASME pressure vessel and piping codes require de-rating of carbon steel components with respect to their pressure-bearing ability. This is due to the tendency of carbon steel to become brittle. With progressively lower operating temperatures, the resultant heavier wall requirements for vessels and piping quickly make carbon steel impractical if not uneconomical. Stainless steel is not subject to the same embrittlement tendencies, and therefore becomes the material of choice for all components.

Conclusion

While all of the design practices described above are highly desirable and should be completely implemented, design development always involves a good deal of compromise among competing requirements. Where space, time, and funds are limited, and when various parties have differing views regarding the importance of possible features, a less-than-ideal design will evolve. If there is one attribute that should be insisted upon and maximized to the extent circumstances will allow, it is capacitance. Adequate buffering in the system will tend to compensate for shortcomings in other aspects of the design such as limited chiller capacity and distribution inadequacies. On the other hand, if capacitance is minimal or absent, system performance is likely to be unsatisfactory regardless of how generously the other components are sized.

References

1. Private correspondence with L. D. Johns, Jr., FES East, March 9, 1998. Data based on R-22 in a single stage compressor producing about 200 tons of cooling; condenser cooled with 96°F cooling water at a 10°F rise.
2. Jandjel, D. G., "Select the Right Compressor," **Chemical Engineering Progress**, Vol. 96, No. 7, 2000, pp. 15-29.
3. Kals, W., "Wet Surface Aircoolers," **Chemical Engineering**, July 26, 1971, pp. 90-94.
4. BAC Product Report: "Advanced Coil Technology Reduces Scale Tendency," Baltimore Aircoil, PDR 49/00.
5. **Perry's Chemical Engineers' Handbook**, 6th Edition, R.H. Perry & D. Green, McGraw-Hill Book Company, 1984, p. 5-48, 49.

Acknowledgements

The author wishes to thank the following members of the PFI organization for their assistance in preparing this article: David Kockler, Kumar Gupta, and Michael DeBellis for their editorial critique, Brian Schindler for preparing the graphics, and Amy Armstrong for facilitating compliance with the submittal requirements.

About the Author



Peter N. Notwick, Jr., PE is Director of Process Technology for the Philadelphia, PA office of Process Facilities Inc. He is a chemical engineer with more than 30 years of industrial experience. For nearly 20 years, he has been engaged in the design of process plants for the pharmaceutical industry. These have included plants for manufacture of chemical APIs, biologics, oral dosage forms, and sterile/aseptic formulation and filling. The locations of these plants have included the US, Puerto Rico, Europe, Mexico, and Singapore. He holds a BChE degree from Villanova University and an MS in chemical engineering from New Jersey Institute of Technology. He is professionally licensed in PA and NJ.

Process Facilities Inc., 1880 JF Kennedy Blvd., Philadelphia, PA 19103.

This article presents the results of an experimental study conducted to support the basic understanding of the rouging phenomenon that often occurs on stainless steel in WFI systems. With the established exposure technique, it is shown that rouging is affected by the surface quality and composition of gas atmosphere.

Using Exposure Tests to Examine Rouging of Stainless Steel

by Troels Mathiesen, Jan Rau, Jan E. Frantsen, Jorma Terävä, Per-Åke Björnstedt, and Benedikt Henkel

Introduction

For many years, numerous cases of red-brown to dark violet deposits on the inside surface of distillation columns, storage vessels, and distribution systems for hot purified water and clean steam have been reported. Due to the visual appearance, those deposits were referred to as *rouge*. Rouge was observed in pharmaceutical Water for Injection (WFI) systems, which are typically made of austenitic CrNiMo steel grade AISI 316L. The formation of rouge is promoted by elevated temperatures above 60°C - *Figure 1*.

Since the presence of rouge is not considered as critical for the water quality as required by current pharmacopoeias, it may represent a potential risk of particulate contamination of pharmaceutical product solutions. Therefore, it may necessitate consistent repeated cleaning operations or proper installation of additional filters at the point of use.

A literature survey gained a wide range of opinions as to the origin of rouge, e.g. localized corrosion in vulnerable areas of the passive film,¹⁻⁹ poor welding including heat tint,^{4,8,10,11} and various surface contamination such as mild steel particles,^{2,7} grinding dust and residues from emery wheels.^{7,8,12} Otherwise, the literature is very focused on the various possibilities for "de-rouging" of pharmaceutical water sys-

tems.^{3,5,8,10,13,14} The two most widely used media for de-rouging are acids and chelants.

In 1997, Jessen¹⁵ reported a strong influence of the composition of the gas atmosphere, which is in equilibrium with the boiling water and the vapor phase on the formation of rouge. Whereas carbon dioxide containing and/or oxygen depleted media strengthen the formation of rouge, saturation with oxygen inhibited the phenomenon. These findings were the basis for the initiation of a new research project in 1999. The main purpose of this project was to reproduce some of the interesting results from the earlier Project Rouge I by limiting the number of parameters within each experiment and to determine the influence of different surface treatments and alloys.

Methods

Materials and Preparation

Coupons for exposure tests were produced from 2.0 or 2.5 mm plate material of the stainless steel grades shown in Table A. Each coupon measures 100x100 mm and includes a center hole (Ø12 mm) and a weld. The welding procedure applied (GTAW) ensured a δ -ferrite content of less than 5% for the austenitic grades (316L and 904L), and between 30-70% for the duplex 2205 grade. Both sides of the weld seam were pickled with HF/HNO₃ based paste. Since rouging often is associated with welds that inevitably occur in WFI systems, only welded coupons were included in the exposure tests.

In order to test extreme surface conditions, the coupons were prepared in either the original finish, a ground or electropolished finish. The major characteristics of the tested materials are summarized in Table B. The ground finish was produced using aluminum oxide fiber disks (P80). Electropolishing and follow-up treatment was strictly controlled and performed in concentrated phosphoric/sul-

Figure 1. Rouging on the internal surfaces of a WFI system.⁵



phuric acid solutions at about 50°C according to HE111-processing (material removal approx. 20 µm). The final treatment of all coupons was chemical passivation in 20% HNO₃ for 30 minutes at ambient temperature followed by DI water rinsing.

Exposure

During exposure, the coupons were mounted on a Teflon hosed titanium (Gr.1) rack. Each rack contained 30 coupons separated by Teflon spacers (1.5 mm) while Teflon strips were inserted for every third coupon. Four identical exposure systems were built from Quickfit parts. Each system included two flasks, i.e., a heated cell containing the coupon rack and a reflux flask. A constant water level was maintained by interconnecting the two cells. Each system was filled with WFI (specific electrical conductivity approximately 1µS/cm) to obtain 80% submersion of the coupons giving a total exposed area of 50 dm.² The exposure tests were conducted with the following gas atmospheres:

- synthetic air
- synthetic air with addition of 1% carbon dioxide
- synthetic air without carbon dioxide. CO₂ was removed by bubbling the gas through a sodium hydroxide solution.
- nitrogen 99.999% (Oxygen level <1 ppm)

The systems were thoroughly purged for three days with the selected gas at a flow of 50 ml/min (mass flow controllers) before turning on the heat. Boiling was then maintained for six weeks at constant gas flow of 25 ml/min.

Evaluation

The coupons were regularly inspected visually to identify any rouging during the exposure period. At the end of the test, water samples were taken from each cell and analyzed for dissolved metals by use of Electrothermal Atomic Absorption Spectrometry (ETAAS) or High Resolution Inductively Coupled Plasma Mass Spectrometry (HR-ICPMS). The exposed coupons were evaluated by their weight-change, visual appearance, and surface morphology. For this purpose, Light Optical Microscopy (LOM) and Scanning Electron Microscopy (SEM) were applied. The deposits collected on the Teflon strips (or coupons) were analyzed by means of X-Ray Fluorescence (XRF).

Results

The experiments have involved two series of exposure tests to study either the effect of different gas atmospheres or different alloy types. In addition to this, both series included different surface conditions of the materials tested.

In the first series of exposure tests, two extreme surface conditions of 316L were tested in four different gas atmospheres. The coupons included a roughly ground surface finish and an electropolished surface finish placed at each end of the rack. The aim of this arrangement was to prove whether different qualities possibly could be combined and distinguished in the same cell.

The first signs of rouge became visible after four days of exposure while only little development was observed during the remaining exposure period. In all cases, rouge was seen as deposits along the water line of the coupons as shown in Figure 2. The most evident rouge formation was seen in the cells purged with nitrogen or air with addition of carbon dioxide. The

two other atmospheres (air and air + CO₂) showed less or no rouge formation. This became clear when the coupons and Teflon strips were studied closely after dismantling the cells - Figure 3.

The visible degree of rouging is connected with an increasing amount of dissolved metals and the metal oxide/hydroxide deposits collected on the strips as shown in Table C. In all cases, the red brown rouge deposit was identified as a ferrous dominated products by using XRF. Deposits analyzed by EDS in an ESEM verified the presence of other alloying elements (Cr, Ni, Mo) and showed only small amounts of carbon (0.9-2.4 wt-%) in comparison to the high amount of iron (30-50 wt-%). It should be mentioned that the same technique revealed the presence of silicon as colorless deposits on the coupons. The glassware is the most likely source for the dissolved silicon since none of the other exposed materials contain considerable amounts of silicon. Microscopic investigation of the surface of

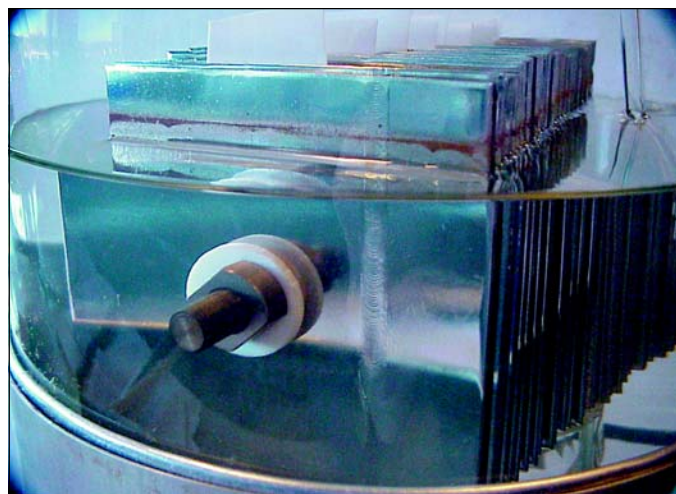

Figure 2. Test cell with a coupon rack showing rouge at the water line after three weeks of exposure in nitrogen purged WFI (boiling was paused). The coupons include both the #80 and the 2B+ep finish of 316L material.

the coupons showed that the rouge product consists of relatively loosely adhered particles - Figure 4. However, since the rouge was evenly distributed on the strips and coupons, the first series of tests did not allow any distinction between the different surface treatments.

Based on these results, the second series of tests were performed separately with each material or surface quality in one cell. In order to produce the most extreme rouging conditions, all tests were performed in nitrogen-purged atmosphere.

From the results in Table D, it clearly appears that the specified and controlled electropolished finish of all alloy types showed less rouging than their untreated counterparts. Furthermore, the untreated finish of the high alloy materials revealed no obvious improvement in performance when compared to the 316L 2B material.

In agreement with the above results, it appears that the metal concentrations are higher in the water samples from the unpolished plates whereas the electropolished counterparts show less dissolved metal - Table D. During the exposure tests, additional water samples were taken after three weeks (316L only). It clearly appears that all coupons release high amounts of iron although the visual rouge formation at that time was limited. Moreover, the iron content is higher than the level of the water samples after six weeks. This difference possibly

Chemical composition of the experimental materials determined by OES ^a (wt-%)										
Material	C	Si	Mn	P	S	Cr	Ni	Mo	N	Cu
316L	0.018	0.51	1.71	0.030	0.002	17.3	12.5	2.6	0.059	0.16
904L	0.014	0.28	1.50	0.021	0.001	19.6	24.2	4.3	0.053	1.43
Duplex 2205	0.022	0.38	1.53	0.022	0.001	22.4	5.7	3.2	0.117	nd.

a) Optical Emission Spectrometry

Table A. Experimental materials.

δ-ferrite content in the weld metal and surface roughness of the tested materials.						
Material	δ-ferrite content in weld metal (Vol.-%) ^a		Surface roughness of tested finishes ^b Average Ra (μm) ^c			
Standard steel	Avg.	Min./Max	2B	2B+ep	#80	#80+ep
316L	3.0	1.4 / 4.1	0.22	0.18	1.03	0.39
High alloyed	Avg.	Min./Max.	2E		2E+ep	
904L	not detectable		0.32		0.11	
Duplex 2205	59.1	51.9 / 66.9	0.21		0.10	

a) measured with a Fischer Feritscope M11 and MP3C (both Vol.-% Fe cal.) b) 2B - according to ASTM A480, i.e. skin passed and pickled finish; 2E - annealed, electrolytically pickled, brushed (grit 100) and finally pickled; ep - electropolished finish according to HE111-processing; #80 - ground finish, mesh 80. c) using contact profilometry (Lt 4.8mm/ Lc 0.8mm).

Table B. Characteristics of the tested materials.

may be due to an initial high release rate of iron and subsequent slow deposition. It should be mentioned that silicon from the glassware also was present in the water samples at concentrations that were approximately 1000 times higher than the metal concentrations.

The exposed coupons were further studied under a microscope to identify any signs of corrosion. None of the coupons showed clear indications of corrosion although the electropolished coupons clearly revealed all forms of imperfections or inhomogeneous structures such as small slag particles or weld areas. The ferrite phase in the welds also appeared clearly on the electropolished coupons, but showed no indications of selective dissolution - *Figure 5*. It is more difficult to exclude the possibility of corrosion on the other surfaces since the evaluation was disturbed by either the intergranular etching (2B finish) or grooves (2E finish).

Discussion

The above results show several interesting effects on the formation of rouge on stainless steel in boiling WFI. First of all, the tests consistently show that rouge is an iron rich product consisting of small particles that accumulates preferentially along the water line or on the Teflon parts. This indicates that the particles are formed at the water level and float until they deposit in stagnant areas at the water/gas interface or on Teflon parts due to electrostatic forces. Rouge also was deposited to a lesser degree below the water level at the Teflon spacers, which verifies that the metal dissolution takes place in the water phase. Unfortunately, this behavior implied that different steel qualities could not be tested together.

The first series of exposure tests showed a strong effect of the gas atmosphere composition although the tests allowed no distinction between the two surface conditions in each cell. The most evident rouge formation was observed in the cells purged with nitrogen or air with addition of carbon dioxide, whereas air and carbon dioxide depleted air showed less or no rouge formation. This result indicates a beneficial effect of oxygen and a negative effect of carbon dioxide that respectively may

improve the stability of the passive layer and cause a slight acidification of the media. It should be noted that the final pH was 5.5 of the carbon dioxide containing media whereas the pH in the other media ranged from 7.6 to 8.1. WFI completely purged of all gases was not included in the study, but would probably result in the same behavior as observed for the nitrogen purged experiment, when assuming that the obtained oxygen depleted conditions in both cases have the same effect on the passivation of the stainless steel.

As concerns the effect of surface treatment, the results of the second series of tests show that electropolishing improves the performance when compared with the pickled qualities (2B or 2E). Both surface conditions are regarded as high quality, and all coupons were prepared with great care involving nitric acid passivation as the final treatment. Therefore, it is believed that the improved performance of the electropolished material is related to a marginally higher purity that possibly affects the passive dissolution rate.

The surface finish probably has a very high impact on rouging. Maybe even higher than the individual stainless steel grades. Therefore when comparing the results of the 316L coupons with the more highly alloyed steel types, there is no obvious improvement although the high alloy steel types possess a significantly better corrosion resistance (mainly against chloride and acid attack). One reason for this could be the fact that 316L is tested with a different surface finish than the higher alloyed grades. This could be one of the reasons why the brushed coupons (2E) show at least the same amount of rouge as the 316L coupons and even higher contents of dissolved iron. The electropolishing clearly improves the behavior of the high alloy steel types, and brings the overall performance up to a level of the best 316L coupons. In fact, the content of dissolved iron for the 904L coupons was below the detection limit.

The surprisingly high amount of dissolved iron for the 2E-samples may perhaps be due to a higher passive dissolution rate for the high alloy materials in comparison to 316L. Fundamental work on the passivation of stainless steel in acids shows that an increasing content of molybdenum may

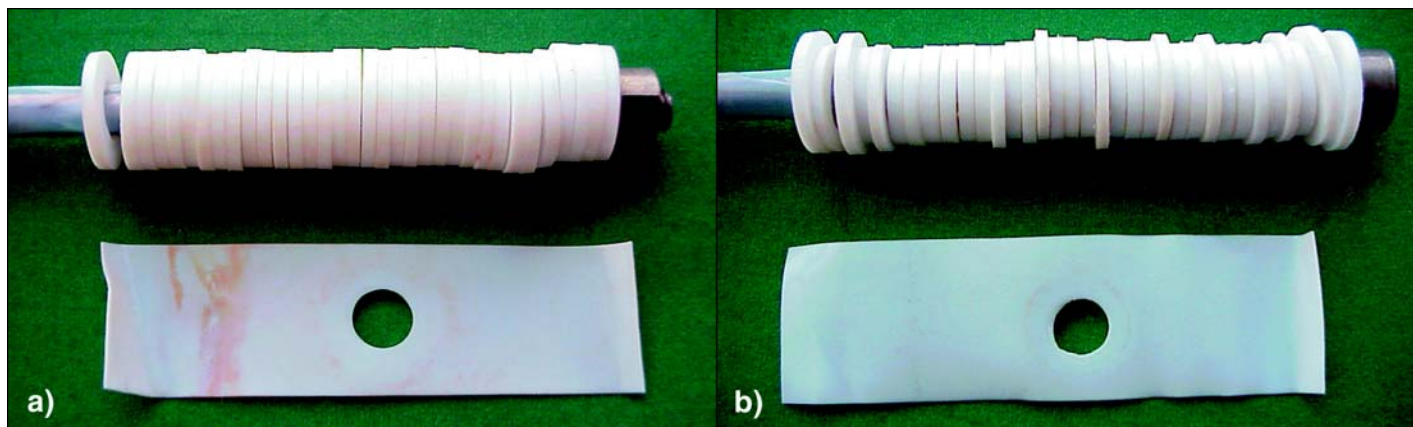

Figure 3. Teflon spacers and strips after exposure of 316L in WFI purged with a) air + 1% CO₂ and b) Air + CO₂.

increase the passive dissolution rate.¹⁶ However, this fact should only be considered as a possibility since the boiling WFI is far less aggressive than the acids used to obtain these data.

The fact that no corrosion was observed on any of the exposed coupons suggests that rouging is the result of slow metal dissolution while the stainless steel remains in its passive state. The possibility of finding any corrosion attack is also weakened by the limited amount of dissolved metals in the water samples.

It is believed that the release of metal (especially iron) is highest during the initial exposure period where the driving force is high due to the low concentration of dissolved metals. Furthermore, the passive oxide film adapts its composition and structure to the surrounding environment during the first

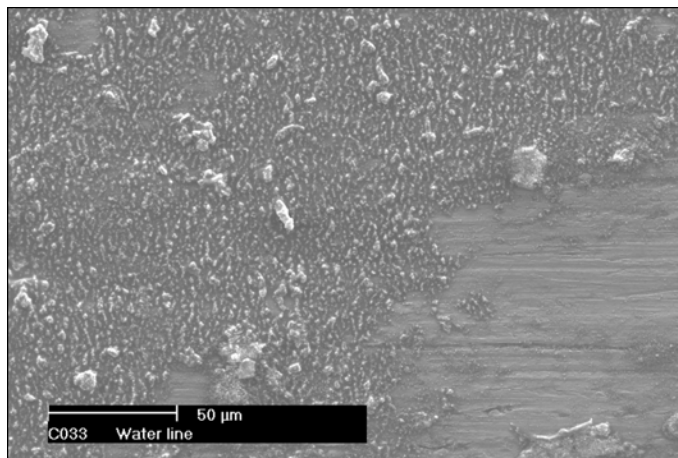

Figure 4. Exposed coupon covered by loosely adhered rouge deposits. Scanning electron micrograph.

hours. This also may contribute to a high initial dissolution rate. The water analysis data and visual observations during exposure support this theory. After a certain period, stationary conditions are probably achieved in the exposure cell as a compromise between the concentration of dissolved metals and the composition of the passive oxide film. This situation differs from the one found in a real WFI system, where the water continuously is consumed and replaced. Therefore, it is considered that the dissolution of metal takes place at a higher rate than indicated by the exposure tests (i.e., less than 20 µg/m²day).

The established experimental technique has, with some success, made it possible to reproduce rouging in the laboratory and thereby study the effects of different parameters. It should

be mentioned that the observed effect of the gas atmosphere previously had been shown using the same exposure technique, but different evaluation methods.¹⁵ Although interesting results were obtained, the established technique is not yet considered perfect due to co-deposition of silicon released from the glassware. This side effect excluded the possibility of correlating the weight-gain of the coupons to the deposition of rouge, and may to some extent also have affected the water chemistry. Moreover, the experimental technique is quite costly since each surface condition had to be tested separately with large number of coupons for a long time to obtain a limited amount of rouge. Efforts are currently being made to refine the above technique and to pursue some of the interesting effects observed in this study.

Conclusion

Long-term tests of partly submerged stainless steel coupons have shown that the rouging phenomenon can be reproduced and studied in the laboratory.

Different surface finishes of 316L steel exposed in boiling WFI purged with different gasses showed that rouging develops faster in atmospheres of carbon dioxide containing air and nitrogen. Purging with atmospheric air resulted in less rouging, while air without carbon dioxide showed no visible rouge formation. The rouge formed was deposited preferentially along the water line or on Teflon parts. The rouge collected was in all cases identified as iron rich deposits. Furthermore, rouging was associated with increased amounts of dissolved metals in the test solution.

Exposure in nitrogen purged WFI of the highly alloyed 904L and 2205 steels in 2E finish showed no obvious improvement in performance when compared to the 316L 2B materials. The electropolished condition improved resistance against rouging and resulted in comparable behavior of the different steel types.

None of the exposed coupons showed any weight-loss or visible signs of localized corrosion. This suggests that rouging is mainly a result of passive dissolution and re-precipitation of metals, mainly iron. It also agrees well with the fact, that rouging may be intensified by any local defect, such as iron contamination, de-alloying or heat tints.

References

1. Self, T., Olsen, P., and Banes, P., "Investigating the Rouging of Stainless-Steel USP Water Systems," *Microcontamination*, Vol. 11, No. 5, 1993, pp. 44-55.

Summary of results of exposure tests including AISI 316L material tested in WFI at 100°C for 6 weeks. The #80 and 2B+ep surface finishes were tested in the same cell.						
Atmosphere	Dissolved metals, ^a µg/l				XRF-iron intensity on Teflon strips	Appearance of coupons and Teflon strips. Visually assessed
	Fe	Cr	Ni	Mo		
Air	20	0.5	3.8	8.4	Weak	Traces of rouge
Air + 1%CO ₂	39	0.8	23	7.4	Strong	Heavy rouging
Air ÷ CO ₂	23	0.6	6.9	7.4	Weak	No rouging
N ₂	130	1.6	9.0	9.6	Strong	Heavy rouging

a) measured using HR-ICPMS (Fe, Cr, Mo) or ETAAS (Ni).

Table C. Summary of results of the first series of exposure tests.

Summary of results of exposure tests of different alloys tested separately in nitrogen purged WFI at 100°C for 6 weeks.					
Alloy	Surface	Dissolved iron µg/l ^a		XRF-iron intensity on Teflon strips	Appearance of coupons and Teflon strips. Visually assessed
		3 w	6 w		
316L	2B	431	37	Moderate	Distinct rouging
	2B+ep	177	6.8	Weak	No rouging
904L	2E		95	Strong	Distinct rouging
	2E+ep		<2	Moderate	Slight rouging
Duplex 2205	2E		365	Strong	Slight rouging
	2E+ep		59	Weak	Very slight rouging

a) Iron content after 3 and 6 weeks of exposure. The iron content of the WFI was 2.9 µg/l.

Table D. Summary of results of the second series of exposure tests.

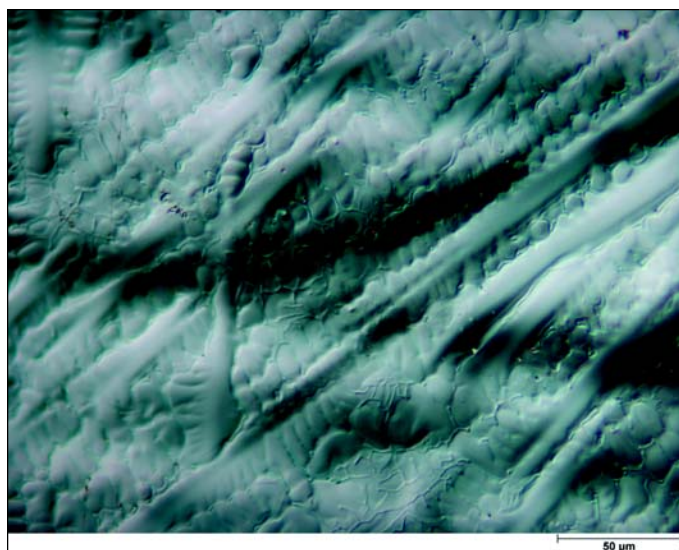

Figure 5. Weld metal of an electropolished 316L coupon. The picture was obtained by light microscopy and shows a small amount of delta ferrite distributed as a skeleton between the primary austenitic phase.

2. Tverberg, J.C, and J.A. Ledden, "Rouging of Stainless Steel in WFI and High Purity Water Systems," Proceedings of **Tube 2000**, Düsseldorf, 2000.
3. Menon, G.R., "Rouge and its Removal from High-Purity Water Systems," **BioPharm**, Vol. 3, No. 7, 1990, pp. 40-43.

4. Grant, A, B.K. Henon, B.K., and Mansfeld, F., "Effects of Purge Gas Purity and Chelant Passivation on the Corrosion Resistance of Orbitally Welded 316L Stainless Steel tubing," **Pharmaceutical Engineering**, Vol. 17, No. 1, 1997, pp. 46-60.
5. Henkel, G., "Edelstahl Entrougen und Repassivieren," **CAV**, Konradinverlag Germany, June 1999.6. Corbett, R.A., "Rouging - A Discoloration of Stainless Steel Surfaces," **Materials Performance**, Vol. 40, No. 2, 2001, pp. 64-66.
7. Coleman, D.C., and Evans, R.W., "Corrosion Investigation of 316L Stainless Steel Pharmaceutical WFI Systems," **Pharmaceutical Engineering**, Vol. 11, No. 4, 1991, pp. 9-13.
8. Evans, R.W., and D.C. Coleman, "Corrosion Products in Pharmaceutical/Biotech Sanitary Water Systems," Proceedings of **Ultrapure Water Expo '99**, Philadelphia, Pennsylvania, USA, April 8, 1999.
9. Jacobs, A.M.P., Lojengs, J.C.K., and Sorge, A.V.V., "Stainless Steel: How Long Will it Last?" **EHP**, Vol. 4, No 2, 1998, pp. 47-53.
10. Evans, R.W., and D.C. Coleman, "Fundamentals of Passivation and Passivity in the Pharmaceutical Industry," **Pharmaceutical Engineering**, Vol. 10, No. 2, 1990, pp. 43-49.

“

Long-term tests of partly submerged stainless steel coupons have shown that the rouging phenomenon can be reproduced and studied in the laboratory.

”

11. Henon, B.K., "Recent Installation of WDI and WFI Process Piping Systems in a Biopharmaceutical Facility," **BED**, Vol. 23, Bioprocess Engineering Symposium 1992, ASME 1992, pp. 53-60.
12. Suzuki, O., Newberg, D. and Inoue, M., "Discoloration and its Prevention by Surface Treatment in High-Purity Water Systems," **Pharmaceutical Technology**, Vol. 22, No. 4, 1998, pp. 66-80.
13. Smith, P., "Derouging of Pharmaceutical Water Systems," Proceedings of ISPE Seminar, **Hygienic Process Systems**, Amsterdam, The Netherlands, 6th-7th Dec. 1999.
14. Evans, R.W., and Coleman, D.C., "Pharmaceuticals. Corrosion Products found in Sanitary Water Systems - Part 2," **Ultrapure Water**, Vol. 16, No. 10, 1999, pp. 34-38.
15. Jessen, C.Q., "Project Rouge," Force Institute, Denmark, 1997.
16. Edström, I.O., Carlén, J.C., and Kämpinge, S., **Werkstoffe und Korrosion**, Vol. 21, 1970, pp. 812-821.

Acknowledgements

The companies of the authors financed the present study and contributed with materials and services. The author group is grateful to Novo Nordisk A/S, H. Lundbeck A/S, Getinge Kemiterm A/S, Alfa-Laval Materials AB, Infracerv Hoechst and USF Ionpure AB who contributed to the initial part of the study.

About the Authors



Troels Mathiesen has served as a Corrosion Specialist at Force Technology since 1997. Mathiesen is responsible for the electrochemical laboratory for corrosion testing and conducts consultancy and research work within this field as well as stainless steel and other corrosion resistant alloys. He received his PhD and MSE in corrosion science and engineering from the Technical University of Denmark where he serves today as an external examiner.

Over the past 12 years, Mathiesen has published several papers on corrosion of stainless steel with particular focus on powder metallurgy, test methods, or microbial corrosion. Mathiesen is a member of the Danish Metallurgical Society and the Danish Electrochemical Society.

Force Technology, Park Alle 345, DK-2605 Brøndby, Denmark.



Jan Rau has worked in the field of austenitic CrNi steel tube systems for the semiconductor and pharmaceutical industry since 1998. Rau is responsible for Quality Management and R&D with major focus on metallurgy and surface analyses. He received his PhD in co-ordination chemistry of group 6 metal carbonyl compounds from the University of

Hamburg.

Dockweiler AG, An der Autobahn 10, D-19306 Neustadt-Glewe, Germany.



Jan Elkjær Frantsen has served as a Corrosion Specialist at Force Technology since 1992. Frantsen's primary work areas are pharmaceutical companies, dairies, and breweries. Over the years, he has obtained comprehensive knowledge of properties and limitations for metallic materials both on the process and utility sides. He received his MSc in chemistry from the Technical University of Denmark.

Force Technology, Park Alle 345, DK-2605 Brøndby, Denmark.



Jorma Terävä has been VP of Engineering at Steris Finn-Aqua since 1996. He is responsible for R&D and engineering of the Finn-Aqua Water Still, Pure Steam Generators, and Steam Sterilizers. Terävä has applied several patents and published papers on water related systems. He received his MSc in mechanical engineering from Tampere University of Tehnology.

Steris Finn-Aqua, Teollisuustie 2, 04300 Tuusula, Finland.



Per-Åke Björnstedt has served as a corrosion engineer at AvestaPolarit R&D since 1998. Björnstedt was responsible for pitting and crevice corrosion related questions and handled corrosion/metallurgy failure investigations. Björnstedt has studied material science at The Royal Institute of Technology in Stockholm. He left R&D in January 2002 for a position as Technical Manager at AvestaPolarit Prefab AB.

AvestaPolarit AB, 774 80 Avesta, Sweden.



Benedikt Henkel has an MS in mechanical engineering (material science and welding technology) from the Technical University of Vienna (Austria). He received his MSE focused on the practical criteria of influence of the delta-ferrite content of thin-walled austenitic stainless steel tubes used for applications in the pharmaceutical apparatus and plant construction during automatic orbital GTAW. Henkel works in the field of surface technology and surface treatment for CrNi steel for applications in the semiconductor and pharmaceutical industry since 1999. He is responsible for the North German department as well as for R&D.

Henkel Pickling and Electropolishing Technology Ltd., Stoissmuehle 2, A-3830 Waidhofen an der Thaya, Austria.

In addition to potential business liabilities, there can be significant costs associated with an autoclave validation process. The practical experience that this article is based on may provide assistance in ensuring an effective, efficient validation process for steam sterilization.

Reprinted from
PHARMACEUTICAL ENGINEERING®

The Official Journal of ISPE
July/August 2002 Vol. 21 No. 4

Practical Guide to Autoclave Validation

by Raymond G. Lewis, PE

Introduction

This article is based on practical experiences gained by the author while conducting hundreds of validation test runs on dozens of autoclaves of varied manufacture. It is primarily intended that personnel who perform validation testing on autoclaves may benefit from these experiences, and that it will assist in ensuring a high level of compliance in the validation process. The article also may be of benefit in selecting an appropriate validation strategy and/or cycle. Personnel unfamiliar with steam sterilization principles or autoclave validation could use the material as a basic training tool and it may be a good refresher for more experienced personnel. A list of definitions and references are provided at the end of the article.

Sterility Assurance Level

The level of microbial inactivation can be described by an exponential function, "Sterility Assurance Level" or SAL. For example, a SAL of 10^{-6} means that the probability of a single viable microorganism being present on a sterilized item/product is one in one million after the item has undergone a sterilization process. A SAL of 10^{-3} means that the probability of a single viable microorganism being present after sterilization is one in one thousand.

The SAL required is determined by the intended use of the item/product. Sterilization

processes associated with parenterals and medical devices that pose a significant risk in terms of the probability and severity of an infection (e.g., implants, sterile fluid pathways, products intended to come into contact with compromised tissue) generally have been sterilized to an SAL of 10^{-6} . Medical device products not intended to come into contact with breached skin or compromised tissue are generally sterilized to a SAL of 10^{-3} .

The remainder of this article is written assuming that a SAL of 10^{-6} is required.

Log Reduction

Achieving a 1-log reduction means to decrease the microbial population by a factor of 10. The bioburden is the number and type of viable microorganisms contaminating an item. A sterilization cycle that provides a SAL of 10^{-6} effectively means that the microorganisms that "could" be present (i.e., bioburden) are killed, and an additional 6-log reduction safety factor has been provided. The following provides an example of a cycle achieving a SAL of 10^{-6} .

- Bioburden (worst case) = 134 CFU (colony forming unit).
- To reduce the microbial population from 134 to 1 = $\log(134) = 2.13$ (i.e., a 2.13-log reduction is required to reduce the population from 134 to 1).
- Applying an additional 6-log reduction will theoretically reduce the microbial population from 1 to 0.000001. This provides a SAL of 10^{-6} or a one in one million probability of a single surviving microorganism.
- Total log reduction = $2.13 + 6 = 8.13$. Therefore to provide a SAL of 10^{-6} with a bioburden of 134 CFU requires a sterilization cycle that provides an 8.13 log reduction.

Figure 1. Empty chamber temperature mapping
(Photograph provided courtesy of Kuhlman Technologies Inc.)



Thermal Resistance Characteristics

The thermal resistance of specific microorganisms is characterized by “D-values” and “Z-values.” A D-value is the time in minutes, at a specific temperature, to reduce the surviving microbial population by 1-log. A Z-value is the temperature change required to result in a 1-log reduction in D-value.

Other time measurement variables pertaining to thermal resistance are “F-values” and “F₀-values.” An F-value is the number of minutes to kill a specified number of microorganisms with a specified Z-value at a specific temperature. An F₀-value is the number of minutes to kill a specified number of microorganisms with a Z-value of 10°C (50°F) at a temperature of 121.1°C (250°F).

Common Misconception and Equivalent Sterilization Time

It is not uncommon to encounter the concept that “121.1°C (250°F) is the temperature required for steam sterilization.” This understanding is not entirely correct. Extensive empirical studies were conducted and one of the critical variables (temperature) was pre-selected. It is not surprising that the temperature selected was an obvious round number in the temperature range of interest (250°F). The F₀-value equation can be used to determine the relative sterilization time at other temperatures as per the following (with Z-value = 10°C):

$$F_0 = 10^{(T - 121.1)/10}$$

where T = temperature (°C) and F₀ = equivalent sterilization time (min.)¹

Table A provides some examples and the relationship follows in graphical form in Figure 2.

As is demonstrated by the data above, sterilization can be achieved using any of these temperatures. The lower the temperature the longer the sterilization cycle required. This is an important concept to consider because there are occasions where the temperature needs to be carefully selected. An example is a liquid that cannot withstand high temperatures. Ideally, the highest temperature that the load can withstand is selected, since this will provide the shortest possible cycle.

Variables Required to Determine an Ideal Sterilization Cycle

An “ideal” sterilization cycle presumes an ideal sterilizing environment (i.e., saturated steam with no air). The ideal cycle can be determined with the following three variables: bioburden, D-value, and required SAL. The following provides some examples:

- Given: Bioburden = 75 CFU, D-value = 0.5 min./log at 121.1°C, Required SAL = 10⁻⁶
Then: Log (75) = 1.88
Log Reduction required = 1.88 log + 6 log = 7.88 log
Ideal Cycle at 121.1°C (250°F) = (7.88 log)(0.5 min./log) = 3.94 minutes
- Given: Bioburden = 1,215 CFU, D-value = 1.6 min./log at 121.1°C, Required SAL = 10⁻⁶
Then: Log (1215) = 3.08
Log Reduction required = 3.08 log + 6 log = 9.08 log
Ideal Cycle at 121.1°C (250°F) = (9.08 log)(1.6 min./log) = 14.53 minutes

Overkill Approach

Determining the bioburden and D-value for all items to be sterilized in a load can be quite time consuming and costly. As a result, for items that are not heat sensitive, an “overkill” approach is generally employed.

An overkill approach avoids collecting bioburden and D-value data by assuming worst-case conditions. A bioburden of 10⁶ of a highly heat resistant spore forming bacteria (*Bacillus stearothermophilus*) is utilized. The D-value at 121.1°C for these bacteria is generally slightly above 2 minutes, and therefore using 2.5 minutes is a good worst-case value.

With a bioburden of 10⁶, to achieve a SAL of 10⁻⁶ requires a 12 (6 + 6) log reduction. Under ideal conditions, the length of an overkill sterilization cycle at 121.1°C is therefore (12 log)(2.5 min./log) = 30 minutes.

Bioburden and D-Value Approach

For items that are heat sensitive and cannot withstand an overkill approach, it is necessary to collect bioburden and possibly D-value data. This will dramatically shorten the sterilization cycle required. For example, if the bioburden is low (e.g., 10 CFU) and even moderately resistant (e.g., D-value = 0.5), an ideal 30-minute overkill cycle at 121.1°C can be replaced by an ideal cycle of 3.5 minutes (7 log x 0.5 min./log). Alternatively, the sterilization temperature could be reduced

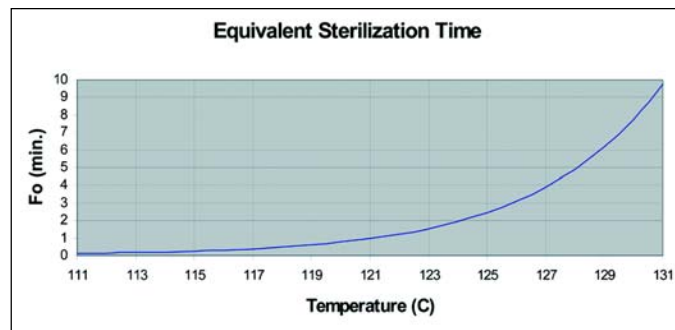

Figure 2. Equivalent sterilization time.

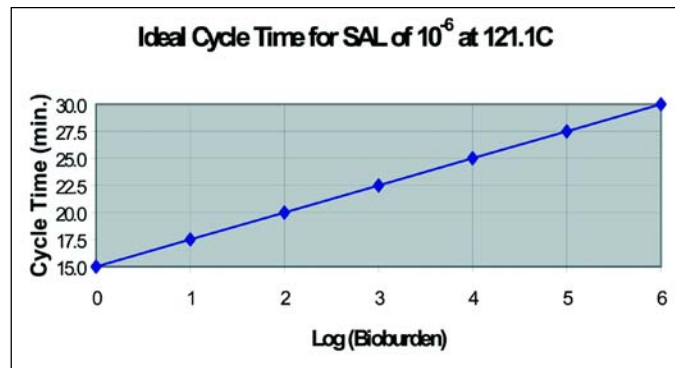

Figure 3. Ideal cycle time.

Temperature	F ₀	Equivalency to 121.1°C (250°F)
115°C (239°F)	0.25 min.	1 minute at 115°C provides the same lethality as 0.25 minutes at 121.1°C
120°C (248°F)	0.78 min.	1 minute at 120°C provides the same lethality as 0.78 minutes at 121.1°C
121.1°C (250°F)	1 min.	1 minute at 121.1°C provides the same lethality as 1 minute at 121.1°C
122°C (251.6°F)	1.23 min.	1 minute at 122°C provides the same lethality as 1.23 minutes at 121.1°C
125°C (257°F)	2.45 min.	1 minute at 125°C provides the same lethality as 2.45 minutes at 121.1°C

Table A. Equivalent sterilization time.

to 112°C and yet only require slightly less than a 30 minute ideal cycle. It may be a significant advantage to reduce the sterilization temperature and/or time.

A compromise approach may sometimes be utilized where bioburden data is collected, but D-value studies are not performed. A worst case D-value of 2.5 could then be employed. This approach will provide a somewhat shortened cycle and avoids the time and cost of D-value studies. Following our example with a bioburden of 10 CFU, the ideal cycle at 121.1°C can be shortened from a 30-minute overkill cycle to a 17.5-minute cycle (7 log x 2.5 min./log).

Figure 3 shows the sterilization time required at 121.1°C for an ideal cycle to achieve a SAL of 10⁻⁶ at varying levels of bioburden (D-value = 2.5 min.).

Vacuum and Non-Vacuum Cycles

Previously, this article has addressed “ideal” cycles that presume an ideal sterilizing environment. In terms of the length of cycle required, one can only approach ideal cycles for items that are easily sterilized. Most often, items/loads with less than ideal conditions are encountered.

There are three basic types of cycles as follows:

a) Hard Goods (Vacuum):

Suitable for items easy to sterilize since air removal and steam penetration are highly effective. Examples are many types of glassware and large diameter piping. A typical hard goods cycle may draw one vacuum prior to introducing steam, reaching the desired sterilization temperature, and beginning the sterilization dwell period. A typical pressure vs. time graph for a hard goods cycle is shown in Figure 4.

b) Wrapped Goods (Vacuum):

Utilized for items difficult to sterilize since air removal and steam penetration are harder to achieve. Examples are gowns, long lengths of tubing, and tanks/vessels/apparatus with small inlet/outlet ports and/or vent filters. A typical wrapped goods cycle may draw three or more vacuums prior to reaching the desired sterilization temperature and beginning the sterilization dwell period. A post sterilization vacuum also is usually drawn to evacuate the steam from the load items. Often the length of time to pull and release the vacuums exceeds the length of the sterilization dwell. A typical pressure vs. time graph for a wrapped goods cycle is shown in Figure 5.

c) Liquids/Gravity Displacement (Non-Vacuum):

Items that contain liquids generally cannot have a deep vacuum pulled or the liquid will be drawn out of the item. Liquid cycles generally just heat up and cool down and do not utilize vacuums. These items may require a lengthy cycle time especially where the liquid volume is large

because the length of time required to heat up and cool down the liquid may be considerable. Another term for a liquid cycle is “gravity displacement” as the air is displaced by gravity (i.e., removing air by introducing steam into the top of a chamber and displacing the air, which is heavier than steam, by removing the air from the bottom of the chamber). A typical pressure vs. time graph for a liquids cycle is shown in Figure 6.

Basic Validation Approach

Installation Qualification (IQ)

The IQ process is intended to demonstrate that the autoclave as installed meets all specifications, is installed properly, and that the supporting programs needed for ongoing operation (e.g., standard operating procedures, maintenance program, etc.) are in place.

An IQ may include the following checks:

- Mechanical Equipment Specifications (chamber, valves, traps, strainers, filters, regulators, vacuum pump, heat exchanger, condenser, etc.)
- Control and Instrumentation Specifications (programmable logic controller, operator interface, printer/recorder, control valves, transducers, pressure and temperature transmitters, resistance temperature devices, switches, level sensors, interlocks, photocells, etc.)
- Site Specifications/Utilities (power, grounding, surge protector, uninterruptible power supply, breakers, water, air, clean steam, plant steam, drain, shutoff / isolation valves, electrical disconnect switches, etc.)
- Drawings Verification (P&ID, mechanical, electrical)
- Construction Materials/Materials in Product Contact
- Approval Documentation (e.g., pressure vessel, electrical, etc.)
- Change/Spare Parts
- Bill of Materials
- Vendor Specification Sheets
- Purchase Orders
- Factory Performance Tests
- Commissioning Report
- Preventive Maintenance Program
- Standard Operating Procedures (operating, maintenance, calibration)*
- Operating and Maintenance Manuals
- Piping Installation Verification (slope, dead legs)
- Weld Inspection/Surface Roughness Documentation/Metallurgical Documentation
- Control System Documentation (system configuration/block diagram, flow sheets, display/report layouts, required interlock considerations, general process limits, conditions for operating over range, hard copy and electronic application code listing, timing diagram, system security, input/output point listing, data monitoring, alarms, software inventory

and version, software configurations, parameter listings, software development and testing records, change control, vendor qualification, modular software development documents, detailed module functional specifications, etc.)

- Instrumentation and Input/Output Dry Loop and Wet Loop Checks**
- PID Tuning**
- Instrument Calibrations**

* Operating Procedures can only be finalized after Performance Qualifications tests are completed when validated load configurations and cycles are known.

** Note: in some approaches, these checks are captured as initial Operational Qualification activities.

Operational Qualification (OQ)

The OQ process is intended to demonstrate that the components of the autoclave operate properly and that the autoclave is deemed ready for performance or load testing.

An OQ may include the following checks:

- Operational Tests (operator/supervisory/maintenance modes, doors, abort and emergency stop, alarms, programmable parameters, menu navigation, security, power-up and shutdown, operator interface display checks, interlock override control, procedure select/start control, step advance control, switch and interlock tests, etc.)
- Power Loss Recovery Test
- Source Code Review
- Filter Sterilization
- Leak/Air Removal/Steam Penetration/Vacuum Hold Test*
- Jacket Mapping
- Saturated Steam Check
- Empty Chamber Tests

* The Bowie Dick test is designed to test air removal, the absence of air leaks and steam penetration into a porous load. It uses a test pack of fabric with specific dimensions or there are commercial, use once packs available. It has been widely employed in Europe. In North America, a Vacuum Hold Test has often been employed. European Standard EN 554 specifies that if a sterilization process includes air removal from the product, a steam penetration test shall be carried out at the commencement of each day the autoclave is used. Although a vacuum hold test may be less sensitive than a Bowie Dick test, the author assumes that a vacuum hold test can be considered as a satisfactory alternative if strict acceptance criteria are applied. This assumption is based on steam penetration/lethality in the worst case load items being demonstrated and that the vacuum hold test therefore demonstrates absence of leaks and that the validated conditions that resulted in lethality are being met on an ongoing basis.

Empty Chamber Distribution Tests (Figure 1)

The basic objective is to show the chamber provides a uniform sterilizing environment. In the opinion of the author, "cold spots" in autoclaves are rarely encountered. Sometimes "cold thermocouples" are misinterpreted as cold spots (refer to following section "Tips").

Three consecutive successful runs are performed for each cycle type with typical acceptance criteria as per the following:

- Throughout the dwell time, all temperatures measured in

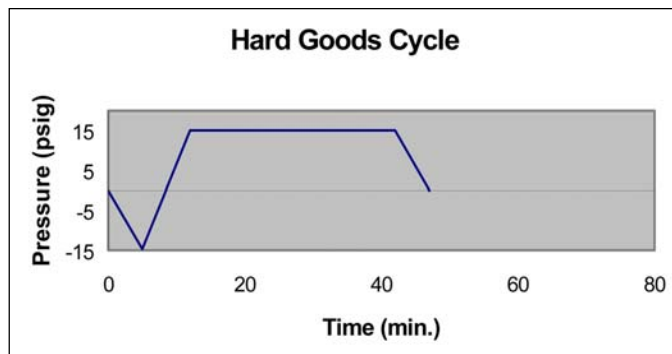

Figure 4. Hard goods cycle.

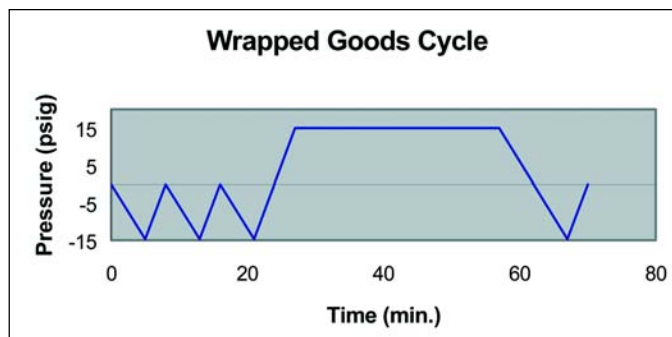

Figure 5. Wrapped goods cycle.

the chamber are within a 3°C band (sterilization temperature + 3°C).² Note: the dwell set-point -1°C/+2°C is often used.

- Throughout the dwell time all temperatures measured in the chamber do not fluctuate by more than 1°C.²
- Throughout the dwell time, all temperatures measured in the chamber do not differ from each other by more than 2°C.²
- The steam is at a temperature corresponding to its vapor pressure.²
- The interval of time between the attainment of the sterilization temperature in the hottest and coldest parts of the chamber does not exceed 15 seconds for chambers of not more than 800L and not to exceed 30 seconds for larger chambers.²
- Timed measurements shall be controlled to an accuracy of $\pm 1\%$.²
- Required pre-certification and post-certification of the data logger ensures that the temperature measurement system is accurate to within $\pm 0.5^\circ\text{C}$.
- The vacuum hold test should achieve a vacuum level of 2.5 psia (with vacuum pump) and maintain the vacuum (without further vacuum being initiated) within 0.4 psi over a period of five minutes.

Performance Qualification (PQ)

Loaded Chamber Steam Penetration Tests

Loaded chamber steam penetration runs are then conducted on every load. Note: this is a very time consuming process, especially if you have a significant number of items to be sterilized. It is necessary to determine which load items are the most difficult to sterilize and which location(s) within the items presents the worst-case conditions.

There are two commonly used methods for determining the worst-case items/locations, thermocouples, and steam integrators. Steam integrators are commercially available strips that provide a quantitative indication of the exposure to steam. The

amount of steam exposure can be determined by measuring the movement of a chemical indicator on the integrator strip. The author recommends utilizing steam integrators since they are designed to measure steam exposure and thermocouples can result in misleading data (i.e., measuring temperature without taking into account whether there is any air present).

Determining which load items are the most difficult to sterilize and which location(s) within the items presents the worst-case conditions can be a daunting task. With a large load containing a wide variety of different types of items, the number of possible test locations seems to approach infinity. It also can be difficult to get the thermocouple and/or steam integrator into the item without adversely affecting the item's ability to be sterilized and/or ruining the item (a concern with expensive items).

One must evaluate an item on a case-by-case basis and determine how best to challenge the item. Often the item must be sealed somehow to return the item to a state that represents equivalency with respect to steam penetration. No attempt will be made to provide an exhaustive commentary here, but rather provide a few basic techniques for answering questions that inevitably arise:

- What is the most difficult point to sterilize in a hose of uniform diameter? Common sense can sometimes assist, dictating in this instance that the most difficult to sterilize point is in the center of the hose.
- How do you get a 10-foot length of thermocouple and/or steam integrator into the middle of a 50-foot hose? You can put a slice/cut into the middle of the hose and insert the thermocouple/integrator through the slice. Note: the cut must be sealed or you will not be challenging the hose properly. You can use silicon to seal the cut. Alternatively, if two 25-foot lengths of the hose are available you can join the two lengths with a connector and insert the thermocouple into the connector. The connector then must be sealed. The advantage here is that you don't ruin the 50-foot hose. The connector technique can be used for small diameter tubing where the hose is too small to insert a thermocouple and/or steam integrator.
- What is the worst-case location within a bottle, flask, or cylinder? This has been shown to be in the center, near, but not at the bottom.
- How can you minimize the number of runs required to challenge a load? Using steam integrators can help minimize the number of runs required to challenge a load. There are a limited number of thermocouples available, but as many integrators as desired can be placed in the load.

Load Configurations

Another variable of concern is whether fixed load configurations or flexible load configurations are desired. A fixed load configuration means that the load to be sterilized will be identical for all future processing runs and that the load is placed in the chamber in exactly the same way for all future processing runs.

In the opinion of the author, the location of an item in the chamber does not influence its ability to be sterilized (assuming that the location change does not involve a change in load density). This observation is based on the experiences of the author in conducting hundreds of validation test runs on dozens of autoclaves of varied manufacture. However, one

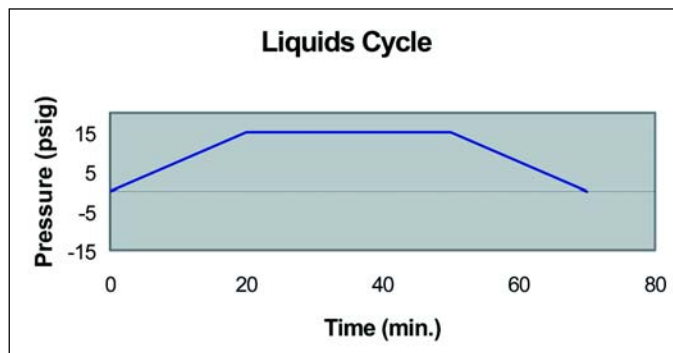

Figure 6. Liquids cycle.

should proceed as if the location within the autoclave is a variable of concern. One can eliminate this variable by rotating the items within a load from run to run and thereby attempt to demonstrate positional equivalency.

For most loads, again in the opinion of the author based on experience, the number of items in the chamber does not influence an item's ability to be sterilized (unless the load becomes so dense that steam penetration/circulation becomes an issue). One should proceed as if this is a variable of concern. You can successfully validate a load while encompassing this situation by performing minimum and maximum load studies.

The following provides an example of fixed vs. flexible load configurations:

- Example load:
 - three (3) flasks
 - four (4) graduated cylinders
 - 24 plastic bottles with vent filters
- Fixed Load/Fixed Position:

In this situation, all of the load items are placed in the autoclave, each time in the same position for each item, and a diagram of the load configuration is available in the procedures so that the operators can reproduce the load for every processing run. This situation will require the least validation runs, but offers no flexibility in load configuration.
- Fixed Load/Variable Position:

In this situation, all of the load items are placed in the autoclave, but the location of the item in the autoclave can vary and only a list of the load items is required for the procedures. The validation runs must demonstrate positional equivalency by rotating the items from location to location during the test runs. It may be possible to accomplish this with the same number of validation runs as above and offers the operators some flexibility in loading the autoclave. This can be an advantage especially for large loads containing numerous items.
- Variable Load/Variable Position:

In this situation, any or all of the load items (i.e., any combination of from 0 to 3 flasks, from 0 to 4 cylinders, from 0 to 24 bottles) can be placed in the autoclave in any position in the autoclave and only a maximum load list is required for the procedures. The validation runs must demonstrate positional equivalency by rotating the items from location to location during the test runs. The validation runs also must demonstrate that the cycle is adequate for both a maximum

load and minimum load configuration. The minimum load tests are done with only one item in the autoclave, that item being the load item demonstrated as being the most difficult to sterilize. This method will require the greatest number of validation runs, but offers the operators a great deal of flexibility in loading the autoclave. This can be a significant advantage in many situations.

Loaded Chamber Biological Challenge Tests

After determining the worst-case items and worst-case locations within items, these items are then challenged with biological indicators (spore strips and/or vials for placement within liquids). A thermocouple should be placed along with each indicator, as the temperature data will be required to extrapolate the cycle to achieve the SAL of 10^{-6} .

Tests are conducted until a cycle time results in three consecutive runs where the biological indicators show no growth. If it is important to achieve the shortest possible cycle, this process can consume a great deal of time as to determine the success/failure point likely requires obtaining failed test results along with successful test results. In addition, it takes time to determine whether the indicators exhibit growth (after two days of incubation you can be reasonably confident whether there is growth or not in most cases). If a few minutes of possibly unnecessary time added to the cycle is not a significant issue, it can be advantageous to attempt to predict a cycle time that you feel will pass. This can save considerable time and validation costs.

Once one has achieved three consecutive runs resulting in no growth and therefore demonstrating a 6-log reduction (assuming you were using indicators of 10^6 spores/strip), the following equations/example show how to extrapolate the full cycle required to achieve the SAL of 10^{-6} :

$$La = [12 \times (Fo/R)] - Fo$$

where La = the additional lethality (F_0) required

12 = used to extrapolate a 12-log reduction

Fo = the minimum accumulated F_0 value from the biological challenge runs at the end of the cycle

R = the log reduction demonstrated (i.e. log [spore population])

$$Fi = 10^{(T-121.1)/10}$$

where Fi = the instantaneous F_0 value

T = the minimum temperature expected during the additional lethality period (Note: this temperature should be taken as the temperature achieved at the end of the dwell period at the challenge location where the minimum accumulated F_0 value resulted)

$$Ta = La/Fi$$

where Ta = the additional time required

$$C = Ta + D$$

where C = total dwell period time required

D = the dwell period time which resulted in the demonstrated reduction

Example Calculation:

The biological challenge runs were performed using spore strips that were enumerated at 1.21×10^6 spores/strip. Therefore $R = \log(1,210,000) = 6.08$

The minimum accumulated F_0 value (at the end of the cycle) from the biological challenge runs was 30.2 minutes. Therefore $Fo = 30.2$ minutes

$$La = [12 \times (30.2/6.08)] - 30.2 = 29.4 \text{ minutes}$$

The temperature in the coldest item at the end of the dwell period was 119.4°C

Therefore $T = 119.4^\circ\text{C}$

$$Fi = 10^{(119.4-121.1)/10} = 0.676$$

$$Ta = La/Fi = 29.4/0.676 = 43.5 \text{ minutes}$$

The biological challenge runs were conducted with a dwell period of 45 minutes. Therefore $D = 45$ minutes

$$C = 43.5 + 45 = 88.5 \text{ minutes (note: this number should be rounded up)}$$

Therefore the dwell period must be 89 minutes to achieve a 12-log reduction.

Three consecutive successful biological challenge runs are performed for each load with typical acceptance criteria consistent with the empty chamber distribution test acceptance criteria and all biological indicators used during the test cycle must show negative growth.

Tips

1. If you are going to draw a vacuum(s), ensure that the load items can withstand the vacuum(s). You don't want to be the person who has to report that the new \$10,000 tank is now as flat as a pancake.
2. Rotate thermocouples from run to run. This avoids misinterpreting thermocouples that read slightly lower temperatures (i.e., cold thermocouples) as cold spots or cold items.
3. Label the thermocouples by number using a small strip of autoclave tape. This will greatly assist with ensuring that you are properly recording what thermocouple was placed in each location and will save validation time.
4. If you are performing a large number of test runs (e.g., over the course of several weeks), strike a compromise between post-calibration verification of thermocouples after every run and at the end of the entire testing period. If you wait until the end of the testing period, you run the risk that all of the runs are of no value due to not meeting the verification acceptance criteria. If you verify after every run, you will add considerably to the length of time required to complete the testing. The author has found that performing the verification every few runs or every few days is a reasonable compromise.
5. Be cautious with the acceptance criteria you employ for post-calibration of thermocouples. If the criterion is too tight (e.g., all thermocouples must meet the acceptance criteria), you may lose a lot of runs if one or two thermocouples cease functioning or are outside of the temperature tolerance after the run(s).
6. Take great care with documenting the validation test runs. The documentation should include: a diagram showing the location of all load items within the autoclave chamber, the items containing thermocouples, integrators and biological indicators, the precise location/number of each thermo



...steam sterilization validation remains a significant issue to regulatory bodies, particularly for processes associated with high risk in terms of the probability and severity of an infection.



couple, integrator and biological indicator within each item, the printout from the data recorder, the printout or chart from the autoclave, the time that the dwell period begins and ends (as per the data recorder time), and the results for each integrator or indicator. Each document should be clearly labeled with the date, test run number, etc. If you fail to generate good documentation while conducting the runs, you will not be able to recover when analyzing the data/ putting together the report, and you will end up with inadequate or poor quality data to support the validation process.

7. A thermocouple should always be placed beside the drain temperature sensor (usually a drain temperature sensor is used to control the temperature within the autoclave).

Cautions

1. If you are using a non-vacuum cycle to sterilize a non-liquid load, you are taking a significant risk. Some regulatory bodies will simply not allow processing of non-liquid loads with non-vacuum cycles.
2. Some regulatory bodies are extremely concerned that all points within the load achieve sterilization temperature when starting the dwell period. This may mean that you are not drawing enough vacuums or that modifications to the items being sterilized are necessary to allow more efficient steam penetration.
3. If you are not using biological indicators to validate your cycle, you are taking a significant risk. Using temperature data alone means that you are assuming ideal conditions where it is not justified.
4. If you are placing a small quantity of water within load items to assist with sterilization, you must have appropriate procedural controls in place to ensure ongoing consistency with the amount of water present during the validation runs and all subsequent processing runs.

Summary

The requirements to validate steam sterilization processes have been documented for many years. For example, perhaps the most historically significant reference guide, the PDA Technical Monograph No. 1 Validation of Steam Sterilization Cycles was published in 1978. Nonetheless, steam sterilization validation remains a significant issue to regulatory bodies, particularly for processes associated with high risk in terms of the probability and severity of an infection. Failure to adequately address this requirement can place the public at risk and lead to regulatory citations/action.

In addition to potential business liabilities, there may be significant costs associated with the validation process. Large numbers of time consuming and costly test runs may be required, and if appropriate consideration is not given to employing the correct approach, unnecessary ongoing operational costs may result.

It is hoped that the practical experience that this document is based on will provide assistance in ensuring an effective, efficient validation process for steam sterilization and that the

end result provides the best possible validated cycle to meet the needs of the specific application.

Definitions

SAL: sterility assurance level.

SAL of 10⁻⁶: the probability of a single viable microorganism being present is one in one million.

Bioburden: the number/type of viable microorganisms contaminating an item.

Overkill Approach: a sterilization approach based on assuming worst-case conditions (a bioburden of 10⁶ of a highly heat resistant bacteria).

Log Reduction: reduce the surviving microbial population by 1 log or decrease the surviving population by a factor of 10.

12-Log Reduction: the log reduction required achieving overkill and a SAL of 10⁻⁶.

CFU: colony-forming unit.

D-value: time in minutes, at a specific temperature, to reduce the surviving microbial population by 90% (one logarithmic reduction).

Z-value: temperature change required resulting in a 1-log reduction in D-value.

F-value: the number of minutes to kill a specified number of microorganisms with a specified Z-value at a specific temperature.

F₀-value: the number of minutes to kill a specified number of microorganisms with a Z-value of 10°C (50°F) at a temperature of 121.1°C (250°F).

1 F₀: the equivalent of 1 minute at 121.1°C (250°F).

Dwell Period: the time period that begins when the autoclave temperature has reached the set-point and ends when the timer has expired.

Worst case items: items in the load which are the most difficult to sterilize (as determined by steam penetration studies).

Worst case location: the location within an item that is the most difficult to sterilize (as determined by steam penetration studies).

Gravity Displacement: a method of removing air by introducing steam into the top of a chamber and displacing the air,

which is heavier than steam, by removing the air from the bottom of the chamber.

Vacuum Cycle: a sterilization cycle that draws one or more vacuums to remove air prior to starting the dwell period.

Pre-vacuum: a vacuum drawn prior to starting the dwell period to remove air.

Post-vacuum: a vacuum drawn after the dwell period has finished to remove steam.

Hard Goods Cycle: a sterilization cycle designed for items for which air removal is not difficult and therefore generally one pre-vacuum is drawn.

Wrapped Goods Cycle: a sterilization cycle designed for items for which air removal is difficult and therefore generally three or more pre-vacuums are drawn.

Liquids Cycle: a cycle designed for liquid loads that generally uses gravity displacement rather than drawing a vacuum.

Bowie Dick Test: a test designed to verify that an autoclave's vacuum phase is removing a sufficient amount of air prior to the introduction of steam into the chamber and tests for air leaks into the chamber.

Empty Chamber Tests: tests with an empty chamber essentially designed to demonstrate that an autoclave provides a uniform sterilizing environment.

Steam Penetration Tests: loaded chamber tests designed to determine the worst-case items and worst-case locations within a load.

Biological Challenge Tests: loaded chamber tests designed to challenge the worst-case locations (within worst case items) with biological indicators to demonstrate the effectiveness of a sterilization cycle.

Steam Integrators: commercially available indicators that provide an indication of exposure to steam.

Fixed Load: a load configuration where the quantity and location of items within the chamber are fixed.

SIP: steam-in-place or sterilize-in-place (often used interchangeably although the level of microbial destruction achieved may differ).

References

1. Validation of Steam Sterilization Cycles: PDA Technical Monograph No. 1 (1978).
2. Sterilization of Medical Devices – Validation and Routine Control of Sterilization by Moist Heat: European Standard EN 554 (1994).

About the Author



Raymond G. Lewis, PE is a Validation Manager for Industrial Design and Construction Inc. (IDC) in Portland, Oregon. In this position, he is responsible for international cGMP regulatory issues involved in the design, construction, and validation of pharmaceutical, biotech, and medical device facilities. He holds a degree in chemical engineering from the University of Saskatchewan and a Certificate in computer science from the University of Regina. Lewis has 16 years of experience in the pharmaceutical/biotechnology industry in validation, engineering, production, facility services, and computer operations.

IDC, 2020 SW 4th Ave., 3rd Floor, Portland, OR, 97201.

Airflow control is important to assure proper air change requirements, space pressurization, and personal safety. However, airflow measurement devices are often misapplied because they are not widely understood. This article seeks to provide the technical understanding needed to select and apply them properly in a pharmaceutical setting.

Reprinted from
PHARMACEUTICAL ENGINEERING®

The Official Journal of ISPE
July/August 2002 Vol. 21 No. 4

Airflow Measurement and Control in Pharmaceutical HVAC Applications

by Ken Kolkebeck

Introduction

The performance of HVAC systems in GMP manufacturing, drug discovery, and animal facilities can be improved by applying permanently installed measurement devices to monitor airflow volumes. Problems related to maintaining and balancing air flow rates for purposes of satisfying air change requirements and space pressurization are solved with volumetric airflow control. Integration of measurement devices with Direct Digital Controls (DDC) allows for the continuous control of air volumes, alarming of failures, and the automatic trending of flow data and alarm histories.

While they offer many benefits, engineers often shy away from active airflow control because the measuring devices are considered temperamental. The perception that measuring and controlling airflow is difficult is tied to the fact that it is one of the least understood areas of HVAC control, and therefore equipment and control strategies are very often misapplied. Once application issues are understood, the design, installation, commissioning, validating, and maintenance of the airflow control devices are no longer problematic and the pharmaceutical user can realize the significant benefits they offer.

Types of Devices Available

For some significant reasons, measuring air flow volume in ductwork is different than measuring flow in pipes. Ducts tend to be larger, most often rectangular, and their paths are far more contorted than their piping system counterparts. While it is usually easy to get the requisite "straight runs" of pipe for flow measurement, getting the same with ductwork is difficult. This difference is accentuated by the fact that air in an HVAC system is transported at duct pressures very close to atmospheric pressure and is highly compressible. These conditions produce a great degree of profile distortion and turbulence which must be accounted for in both the design and application of the measurement device.

Most airflow measuring devices offered commercially today are descendants of the pitot traverse methods used manually for balancing HVAC system air volume. The manual determination of air volume requires acquiring multiple point velocity readings across the face of a duct, perpendicular to the airflow direction. These readings are then summed to determine the average face velocity and then multiplied by the area of the duct to find the total volume of flowing air. Single point velocity measurement commonly used in pipes is not appropriate be-

Figure 1. Elements of a Pitot airflow measuring device.

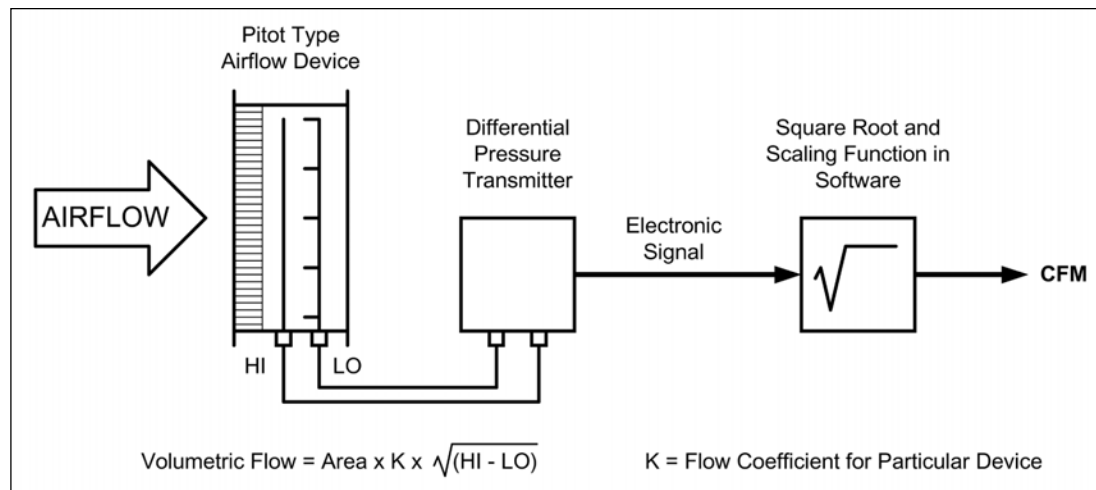

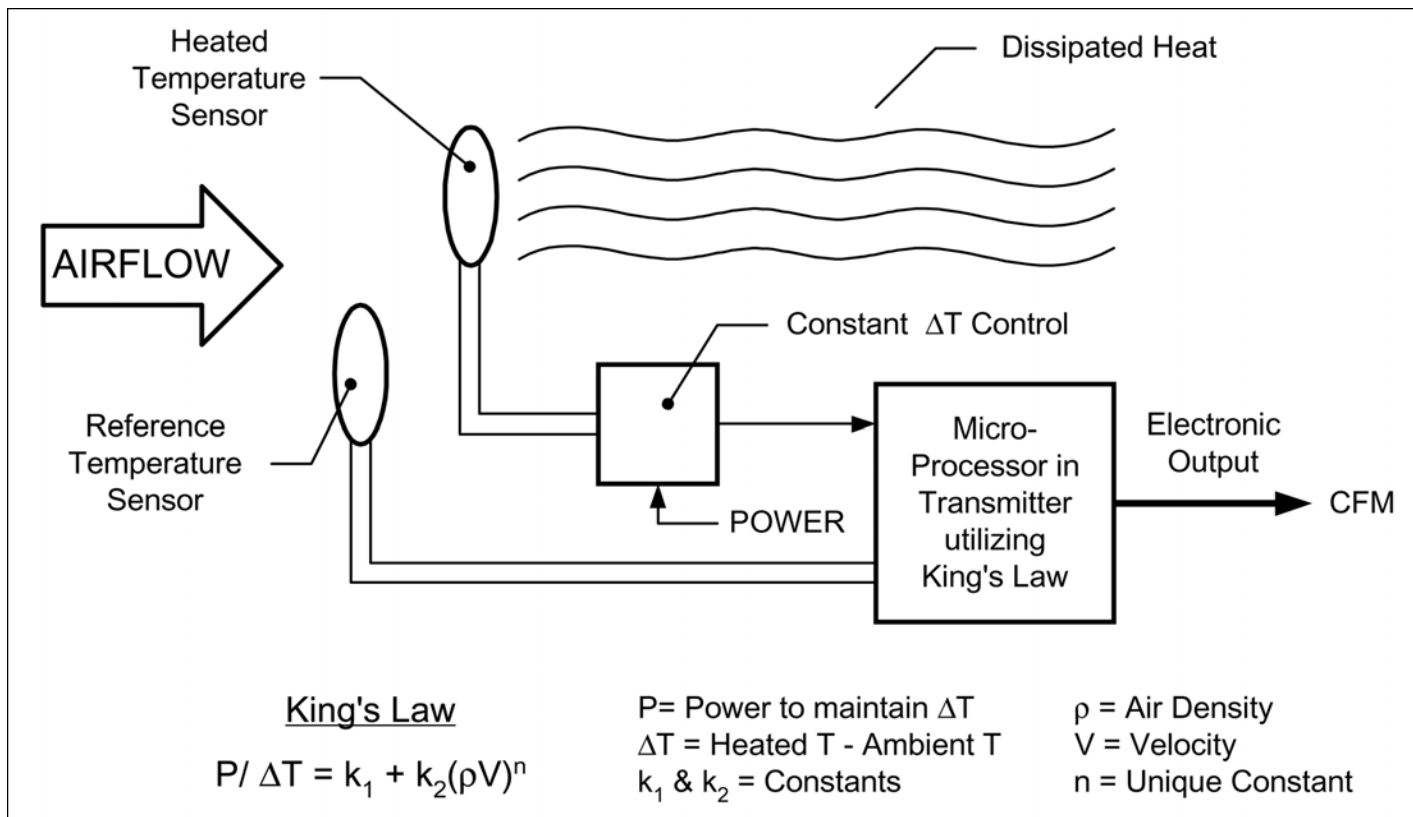

Figure 2. Principle of operation, thermal velocity sensor.

cause the sufficient straight runs required to create a uniform flow profile over a wide range of flow conditions are rarely available in HVAC ductwork. Unlike gas flow measurements in pipes, HVAC air flow need not be pressure or temperature compensated because conditions are so close to the standard conditions of 14.67 psia (1 bar) and 68°F (20°C).

Three predominant technologies are used for continuous flow measurement in ducts; differential pressure producers, vortex shedding devices, and thermal anemometers. For reasons associated with technical difficulty and high cost, ultrasonic technologies based on time of flight and Doppler shift have not proven commercially viable for airflow measurement in HVAC ducts. As offered for service in all, but the smallest HVAC ductwork, commercially available units for each technology come in multipoint velocity averaging configurations with electronic output signals that are compatible with most DDC systems.

Differential producing units utilize an array of high and low pressure tubes with holes drilled strategically along the length of the tubes to traverse the duct face - *Figure 1*. The high pressure tube array has holes drilled on the side facing into the airflow and they sense total pressure which is the static pressure in the duct plus the velocity pressure created by the pressure of air impacting the holes. The method of generating the low pressure varies depending on the specific manufacturer, but the most common method has holes drilled at 90° to the airflow direction so as to only sense the static pressure component. The difference between the high and low pressures sensed is indicative of the flow volume or velocity. The analog value of the pressure developed is measured by a transducer and fed electronically to a control system where duct area and a flow constant are multiplied by the square root of the differential pressure to calculate the flow volume.

Vortex shedding devices use an array of individual sensors arranged across the face of the ductwork to sense point velocities. Each sensor includes a trapezoidal “shedder” element which creates eddy currents or vortices as the air moves over it - *Figure 2*. As eddies alternately form and shed from the sides of the shedder, they create pressure “pulses” which are directly proportional to the velocity of the air. Transducers sense the pressure fluctuation frequency from individual shedders. Companion electronics convert the multiple sensor frequencies to velocities which are averaged and scaled before being sent to the DDC system as an electronic output signal.

Like the vortex shedding devices, thermal anemometer systems utilize an array of sensors to measure point velocities. Each sensor incorporates two temperature sensors, each with a known relationship between electrical resistance and surface temperature - *Figure 3*. One sensor measures duct air temperature while the other has a current applied sufficient to hold it at a fixed temperature differential above duct temperature; usually 50°F (27°C). The amount of current required to hold the differential temperature is measured and used in a formula utilizing King’s law to determine the point velocity. The electronics then average the point velocities to determine the average velocity through the unit and hence the volume.

The duct mounted elements in the differential pressure and vortex shedding devices fit the definition of a “primary element” because they convert air velocity to a more easily measured physical property; differential pressure in the case of the former and pressure pulse frequency for the later. The accompanying secondary elements which are transducers measure these quantities and convert them into an electronic signal. Thermal devices utilize active elements which measure the velocity directly. The performance characteristic of individual thermal sensors must be quantified at the factory and

programmed into the electronics.

The benefit of a primary-secondary type of device is that the performance of the duct mounted primary is a function of the geometry of the sensor which is fixed and will not change over time unless mechanically altered; in essence, the primary calibration can not "drift." Technically, from the standpoint of calibration, the user need only be concerned with maintaining the calibration of the companion transducer. The maintenance requirements of each type of device are largely a function of the condition of the air flowing in the duct. Because they stagnate the velocity at the point of impact, total pressure holes on differential pressure devices tend to collect dirt if the air stream is fouled or water if the air is saturated. Likewise, any build up of dirt on the surface of thermal sensors or water mist in the air will change the heat transfer characteristic of the sensors adversely affecting the accuracy. Vortex shedding sensors will be more robust in this regard, but may eventually foul if subjected to sticky particulates that are common in coating pan exhaust flows. In these applications, provisions should be made to facilitate removal for periodic cleaning which should not damage either of the three sensor types.

Table A presents the performance characteristics of each technology although products from individual manufacturers may vary.

Selection and Sizing of Devices

Several important application issues must be understood and evaluated before selecting and sizing a device. These are the expected maximum and minimum controlled flow rates, airborne contaminants, and installation limitations. Duct pressure and air temperature need only be considered if they exceed what is normally encountered in HVAC systems. The designer must be very realistic about defining the application requirements first and then selecting the device to match. Yet to be invented is the perfect measurement device, capable of meeting every application, so proper selection is the key to success.

The maximum controlled flow rate defines the upper range of the volumetric flow that is required by the application and correspondingly the lower is defined by the minimum. Note that zero flow does not constitute a minimum, even though the system may achieve it when either the fan is off or the damper is closed. Both the minimum and maximum flow volumes should be converted by calculation into flow velocity at the point of measurement because the limits of operation for duct airflow devices are set by velocity, not volume. The turndown ratio is the maximum flow expected divided by the minimum, and is important because some flow measurement technologies provide wider turndown than others.

Many pharmaceutical exhaust applications have corrosive fumes, condensing moisture, hair, dander, or agglomerating

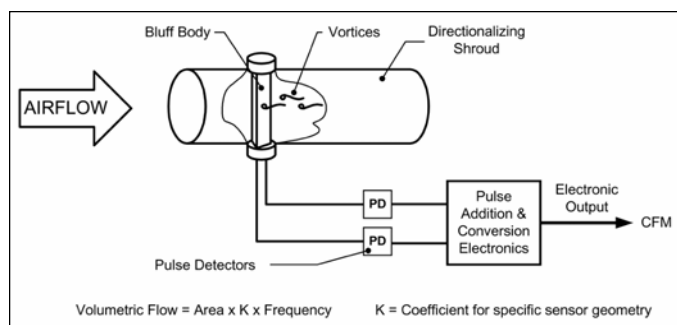

Figure 3. Principle of operation, vortex shedding sensor.

particulates so the expected level of contamination must be considered. Contamination may eliminate some technologies as well as determine the appropriate materials of construction. Combustibles present in either the measured air stream or the air surrounding the accompanying electronic instrument will drive the need for either intrinsic safety or explosion proof construction.

Devices should be sized based on the application requirements first, and the designer's specified duct size last. The fact is that most application problems result when either the measurement device or accompanying control damper is blindly selected to match the duct; an error routinely made when using airflow measurement and control devices in ductwork with coils and filters which require low face velocities. Over-sizing forces the flow measurement device and control dampers to operate at the bottom fringe of their performance range. Once this error is committed, the only solution is to replace the device and a section of duct in the field with a smaller one. By comparison, the first cost of duct transitions is small, smaller area flow devices are less costly, and the resulting increase in system pressure loss is mostly recoverable.

Locating Devices

All commercially available airflow measurement devices are affected by duct conditions up and downstream of the device. While commercially available devices are designed to handle the twists and turns in the ductwork, extremes create turbulence which degrades the performance of the device. Each manufacturer offers suggestions for mounting limitations in the form of a "Minimum Installation Requirement Guide," however, these should be taken for worst case guidance only. The designer must realize that the recommendations typically show only one duct disturbance producing mechanism located either up or downstream of the device, and in only one plane. The reality is that in the typical ducting system there are multiple turbulence producing mechanisms, which exist both before and after the device, and in three planes. Therefore, the designer should try to achieve the best possible locations based on the space constraints at hand and not just focus on achieving the minimums. The locations should be reviewed again when sheet metal shop drawings are received because it is common for the contractor to change locations to minimize fabrication costs.

Keeping in mind that turbulence is the principal cause of device inaccuracy, using the following rules will keep the designer out of trouble. First, strive to keep the minimum flow velocities above 500 fpm (2.5 mps). Turbulence and flow profile distortions are more prevalent at low velocities. Second, avoid locations close to the discharge of obstructions in the ductwork such as humidifier grids, smoke detector tubes, etc. Use common sense when assessing these.

Third, avoid locations where air is decompressing such as at the discharge of a fan or damper, after elbows, and after expanding transitions upstream of filters and coils. In these locations, air velocity is dropping and physics dictates that the kinetic energy associated with the higher velocity must be transferred so much of it goes to turbulence. One of the most common yet easily avoidable mistakes is to locate the airflow sensor after the control damper rather than before. Control engineers do this intuitively because in most control applications, the sensor must come after the adjusting device; as is the case with a temperature sensor and a heating coil. As the airflow volume entering a flow sensor and damper is the same

Capability	Pitot with Transducer	Vortex Shedding	Thermal
Inherent Sensor Curve	Square Root	Linear	Power
Velocity Range Ultra Low; <350 fpm (1.75 mps) Low; 350 to 750 fpm (1.75 to 4.0 mps) Mid Range; 750 to 5000 fpm (4 to 25 mps) High; >5000 fpm (25 mps)	Poor Fair Excellent Good	Poor Good Excellent Good	Excellent Excellent Good Fair
Secondary Device affecting system accuracy?	Pressure Transducer	None	None
Usable Turndown	4 to 1	15 to 1	10 to 1
Performance in various flow streams Clean air High moisture, non-condensing High moisture, condensing Corrosive vapors (w/compatible materials) Particulates, Powder, Dander, Animal Hair	Excellent Good Poor Good Fair to Poor	Excellent Good Good Good Good	Excellent Good Poor Fair Fair to Poor
Complexity	Simple	Moderate	Moderate
Bench Calibration Method	Pressure Source	Frequency Generator	Air Velocity Source
Field Calibration Method	Duct Traverse	Duct Traverse	Duct Traverse
Relative Cost based on small duct and galvanized construction. Pitot will be highest if stainless steel.	Lowest	25% more than Pitot	25% more than Pitot

Table A. Airflow measurement device performance.

as what exits, this is neither necessary nor advisable. Dampers create tremendous turbulence, and therefore flow devices should be mounted upstream of them.

The majority of pharmaceutical applications are for zone control and this translates to relatively small flow volumes and ductwork. The smaller size means comparatively short lengths of up and downstream ductwork are needed to create workable duct locations which are better than the minimums required by the manufacturers.

Presented in Figure 4 is an installation detail for an optimal flow station installation in an application which must be validated. The layout includes a reduction in duct area which serves to both increase the velocity and compress the flow. Just as decompression is to be avoided, compressing the airflow actually improves the performance of the station and reduces the need for straight runs of ductwork. The detail also includes a straight run section ahead of the flow device to allow manual traverse readings for validation purposes.

The installation of a section of three inch (7.5 cm) deep by half inch (one cm) diameter cell flow straightener is inexpensive and advisable in most supply and clean exhaust applications. While it does not modify the velocity profile across the duct face, straightener does reduce turbulence and directionalizes flow so it is parallel to the walls of the duct. Flow straightener is available in a frame from flow device manufacturers and while not absolutely required, it significantly quiets both the device and traverse measurements. For maintenance reasons, straightener should not be used in applications with particles or corrosive fumes.

Device Accuracy

Customer expectations for accuracy are often tighter than reasonably achievable in the field which creates a variety of unintended problems. The first reason is the tendency to specify the datasheet or reference accuracy of the flow measurement device; most commonly plus or minus two percent of reading. The second is the misconception that manual field measurement verification techniques can produce check accuracies of the same order of magnitude as the flow device.

The wide size and volume variations of duct airflow devices adds to the difficulty of obtaining traceable bulk airflow measurements. NIST calibration services for bulk air (gas) volume measurements limit meter size to a maximum of eight inch diameter and so achieving traceability is most often accomplished by referencing to traceable air speed instrumentation. An alternate method utilizes flow nozzles with known pressure drop characteristics and traceable differential pressure measurement instrument.

Up until recently, there have been no uniform standards for airflow measuring device manufacturers to rate their products. Most manufacturers determined the reference accuracy by testing one size sample in what can only be described as perfect conditions. These reference conditions produce optimal inlet conditions and repeatable results, but being devoid of the twists and turns found in the typical ducting system, rarely reflect the installed performance the user can expect to achieve in the field.

The majority of testing standards often referenced for the determination of airflow volumes are for either lab use or manual field duct traverses. These include the ACGIH method,¹ ASHRAE standards 41.2-1987,² and 111-1988³ as well as ISO standard 3966.⁴ In the mid 90s, in an attempt to harmonize the test methods and achieve some accuracy rating stability, a test standard was developed by the Air Movement and Control Association International (AMCA) specifically for permanently mounted airflow measurement devices. The AMCA standard was subsequently adopted by ANSI in 1997 as an American National Standard and became ANSI/AMCA 610-95.⁵

AMCA/ANSI 610-95 suggests testing results for one size are not scalable, and therefore should be conducted on a wide variety of small to large sizes. The AMCA test method utilizes three different configurations or "Figures" as shown in Figure 5. AMCA Figure 1 is essentially a reference condition with no up or downstream obstructions. Figure 2 tests a flow station after an elbow and Figure 3 tests the flow station located before a modulating damper. It should be said that when specifying datasheet accuracy, most manufacturers list only the Figure 1 accuracy determination which yields the best accuracy and is

consistent with the pre-AMCA datasheet accuracy. Accuracy derived from Figures 2 and 3 will typically not be as good, but should be requested as the data is more indicative of field conditions.

When evaluating device accuracy for a specific application, the designer should calculate the total measurement system accuracy in terms of a percent of reading at the minimum and maximum flow readings. With differential pressure producing measurement systems this is complicated because the accuracy of the primary device is usually expressed in percent of reading while the transducer is expressed in percent of full scale. To determine the transducer accuracy, it must be converted from the plus and minus pressure reading at a specific flow to the corresponding plus or minus flow volume - *Figure 6*. This is then used to determine the transducer accuracy as a percent of flow reading. The total measurement accuracy is then determined by calculating the square root of the sum of the squares of the individual device accuracies.

Rules of thumb, while having some basis in science, typically evolve based on experience and such rules can be stated for airflow measurement devices in typical applications. When devices are properly sized and located, minimum velocities are kept above 500 fpm (2.5 mps), and turn down requirements are within those specified for each of the devices, achieving an installed accuracy of $\pm 5\%$ of reading is within reason. The extent to which accuracies will deviate when turn down or low velocity limits are pushed will vary based on the particular type of device technology.

Field Verification

The installed performance of airflow measuring devices should always be verified in the field by manual traverse techniques, even if the application will not be validated. The obvious reasons for doing so are to confirm that the device is calibrated correctly and the corresponding input to the control system is properly scaled. However, the most significant reason for doing so is to account for what might be termed the "system effect." While a commonly used term for describing why an installed fan does not achieve specified performance, the "system effect" phenomenon is also applicable to airflow devices.

Simply put, because of the individual nature of twists and turns in the ductwork in each application, in very few cases will the output from the flow device line up exactly with the verification by airflow traverse. In fact, discrepancies of up to ten percent may be observed. However, if the airflow measurement device has been properly sized and located, repeatability will be excellent and the deviation can be corrected with confidence.

The question then becomes, what should be corrected: the calibration of the flow device or the scaling in the controller receiving the flow signal? Surely either method is acceptable, but it is the writer's opinion that the adjustment of the flow calibration factor in the controller is the best place to make this adjustment. By doing so, calibration of the flow device remains traceable to the factory and calibration of the controller remains linked to the device location in the field. If the flow measurement device must ever be repaired or replaced the manufacturer is likely to ship a unit calibrated to the original standard. When installed and connected to the controller with the location specific calibration factor, the device will work accurately. Of course, any such adjustments should be noted in the calibration records for the device so a record exists of what the correction was and why it was made.

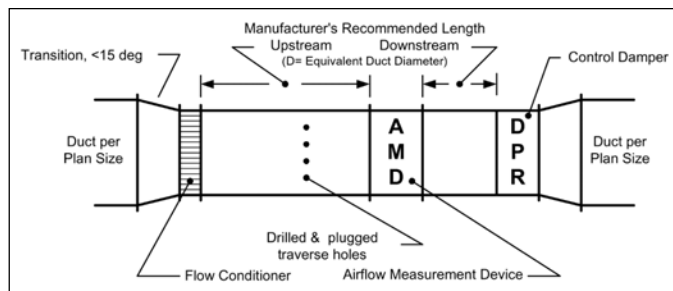

Figure 4. Flow station installation detail.

The accuracy of the field testing and calibration is subject to the methods and equipment used as well as the technique of the individual taking the manual readings. With regard to rectangular ducts, there had been significant controversy⁶ as to which method of point placement is more accurate, the equal area method or more complicated logarithmic Tchebycheff method. Published comparison testing of the two methods⁷ would indicate the selection of the traverse location has more to do with the accuracy achieved than the method used.

Individual pharmaceutical companies should standardize on one of the previously referenced field testing standards. The procedure dictated by that standard should be clearly defined in an SOP and used without shortcuts. Finding good locations at which to perform the traverse is critical to achieving accurate readings. The suggested installation detail in Figure 4 includes a location for traverse readings to eliminate this variable.

Point velocity measurements are typically made with either a pitot tube and electronic manometer, or a portable thermal anemometer. Modern instruments include a wide variety of convenience features including automatic conversion of pitot pressures to flow velocity and multi-point averaging. Some also will allow the entry of the duct size so the test instrument will automatically display volume. The author would suggest not using this feature, having witnessed on more than one occasion the wrong duct area being inadvertently entered. Record the average velocity and duct area separately, then perform the math to obtain duct volume. While requiring an extra step, this provides the ability to retrace how a device was calibrated should a question ever arise. Recording individual traverse points is also of value because the data helps to understand the velocity profile which is needed to evaluate questionable measurements.

Even with the proper standardized procedures in place, it is likely that two individuals using the same test equipment in the same traverse location will get different results. This is attributable to the differences in the handling of the equipment. Still, when an accepted procedure is used, traverse locations are good, quality test and measurement equipment is used, and the technician is careful; accuracies of $\pm 5\%$ should be achievable by field traverse. Of course, these accuracies will degrade quickly if either of the key ingredients is left out.

Many test and balance contractors will utilize an alternative device called a capture hood to determine flow. A capture hood determines the volume supplied or exhausted to the room through individual registers, grilles, or diffusers. Readings from all devices served by the duct with the airflow measurement device must be summed to determine the flow through the duct. Capture hood readings are easier to make than multi-point duct traverse because they can be made from within the room and fewer individual readings are generally required.

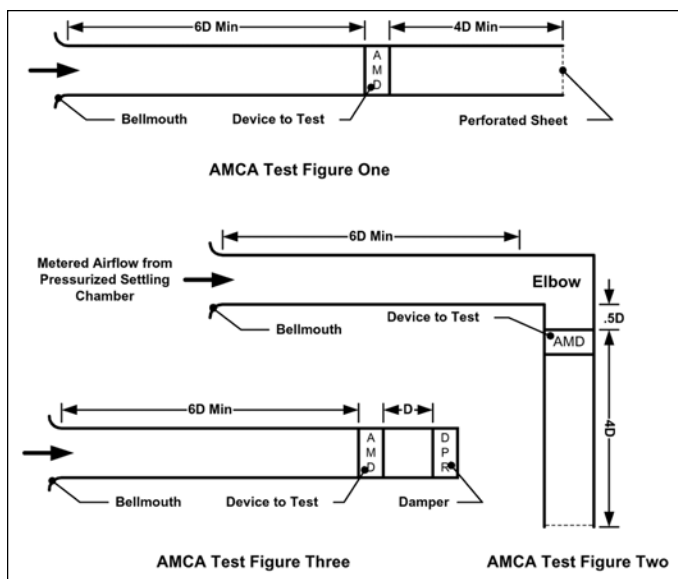

Figure 5. AMCA test configurations.

The author would warn against using capture hoods unless good traverse readings are impossible to obtain. The capture method is particularly problematic because hoods are inherently less accurate, do not seal tightly to the diffusers, and will not account for leakage in the duct between the flow measurement device and the room. Furthermore, at the end of a long day of taking capture hood measurements, it is not uncommon for the test and balance technician to omit one or more diffusers, or add in diffusers which are served by another duct. While using capture hoods to measure exhaust flows is a common practice, published reports⁸ of errors in excess of 25% at low flows give reason to believe results obtained with this technique should be scrutinized carefully.

When comparing the results of a duct traverse with the output of a flow device, one must not become carried away with attempting to get the devices to match perfectly. Given the previously explained expectation of achievable accuracies of $\pm 5\%$ of reading for both the installed device and the test traverse, RSS analysis indicates it is possible for the difference between readings to be 7% apart, yet the actual flow to be equal. This is because the reading from each device is within its tolerance envelope. The author would suggest that if the readings are within the combined tolerance envelope for both the installed and test devices, no corrections should be made. Successive calibrations will only serve to frustrate those involved in the process without an improvement in the end result.

If the readings are outside of this tolerance, the traverse and associated math should be questioned first, then the controller scaling, and finally the flow measurement device. Many a device has been needlessly adjusted because of traverse errors, equipment problems (like cracks in the pressure tubing), or an error in measuring the duct dimensions which caused the area to be incorrect.

Using Airflow Measurements for Closed Loop Control

Oftentimes complaints about the stability of airflow control loops and the resultant "hunting" are incorrectly attributed to the measurement device. Unlike the control of temperature, which is a relatively slow process given that heating and cooling coils have thermal inertia, airflow changes almost

instantaneously when a damper is moved. The speed makes tuning quite simple and dictates low proportional gains with fast integration rates. Derivative control is not used for airflow in HVAC systems. Instability is most often caused by using temperature control tuning constants for flow control.

Other factors which can contribute to control loop instability are dead-band (a.k.a. slop) in damper linkages or slow damper actuator speeds. Electric damper actuators tend to be slower than their pneumatic counterparts, but this should not be a problem (unless the process dictates a high speed as with fume hood control) if the integration rate is properly matched to the actuator speed. The same is true of pneumatic damper actuators because of the time required to pump up or bleed down the air volume contained in the control lines or the actuator itself. Using a high capacity electronic to pneumatic converter (I/P) may not solve the problem if the connecting line is long and highly restricted. Placing the I/P at the damper will help with this problem. Pneumatic piston actuators should have wide spring ranges and pilot positioners are strongly recommended. Following these rules and understanding the nature of the problems can prevent many hours of tuning frustration and headaches.

Flow control loops should never be used in series within the same ductwork system and this mistake is made often. A common example is to measure and control the individual flows to zones served by an air-handler, as well as the total air-handler flow by modulating fan speed with a variable speed drive. It is inevitable that the supply fan flow loop will conflict with the zones, resulting in instability. It is better to let the fan capacity be controlled by static pressure so that controls can match the fan speed to the inlet duct pressure requirements of the zone flow controls. Properly setup and tuned, a change in flow at one or more zones should never destabilize control at any other zone, or at the fan static pressure controller.

Other Flow Devices

A special type of flow measurement device is available which is designed for mounting in the inlet of a fan. Fan inlet probes have become a common problem solver when it is impossible to find good flow measurement locations in the ducting system. Probes are installed in the inlet of a fan and take advantage of the compression that occurs in the inlet bell which improves flow profile.

While they work well, the author feels fan inlet sensors should be used as a fall back and not the device of first choice. This is because fan inlet probes induce turbulence into the inlet of the fan, and therefore can negatively affect fan performance. While this impact may be negligible on a fan with a large inlet or low inlet velocities, it becomes significant if the fan is small or inlet velocities start exceeding 5000 fpm (25 mps).

The correlation between the factory calibration and field readings with fan inlet probes is less predictable than duct probes and dependent on the inlet conditions at the fan. Factors such as inlet duct configurations, belt guard placement, and distance to the air-handler walls can have a significant effect on the "out of the box" accuracy. While the readings are repeatable, calibration corrections as great as 25% are not uncommon.

Finally, there is a class of flow control devices which do not measure flow, but because of their wide use merit discussion. Not to be confused with venturi type differential producing flow meters, venturi valves are self-contained volumetric flow regulators. Much like the ubiquitous pressure regulators found

throughout most facilities, venturi valves rely on a spring controlled force balance mechanism to control the flow volume at a specific setting. The specific flow setting is determined by the positioning of an external lever which is done either manually by a balancing technician or automatically by an electro pneumatic positioner.

Venturi valves do not inherently measure flow, although they can be purchased with what is called a "flow feedback signal." However, this signal is an electronic prediction of what the flow should be given the specific lever position; not what it actually is. In applications where the flow must be known to the operator or recorded for batch records, the author would suggest that the flow be measured by an independent flow sensor of the types discussed previously.

Conclusion

When properly selected, sized, installed, and applied, permanently installed air flow measurement and control equipment can be incorporated into a control system with a minimum amount of problems. The knowledge offered in this article will set the user and designer on the path to using airflow devices in pharmaceutical applications with success. More importantly, the benefits of controlling air change rates and flow balances for safety, product quality, and space pressurization can be realized.

References

1. **Industrial Ventilation, A Manual of Recommended Practice**, 22nd ed., Cincinnati, OH, American Conference of Governmental Industrial Hygienists, 1995 section 9.3.
2. **Standard Methods for Laboratory Air-Flow Measurement**, Standard 41.2-1987, Atlanta, GA, American Society of Heating Ventilation and Air Conditioning Engineers, 1987.
3. **Practices for Measurement, Testing, Adjusting and Balancing of Building Heating, Ventilation, Air-Conditioning and Refrigeration Systems**, Standard 111-1988, Atlanta, GA, American Society of Heating Ventilation and Air Conditioning Engineers, 1988.
4. **Measurement of Fluid Flow in Closed Conduits - Velocity Area Method using Pitot Static Tubes**, ISO

3966:1977, Geneva, Switzerland, International Organization for Standardization, 1977.

5. **Methods of Testing Airflow Measurement Stations for Rating**, ANSI/AMCA 610-95, Arlington Heights, IL, Air Movement and Control Association International, Inc. 1997.
6. MacFerran, Ernest, "Equal Area vs. Log-Tchebycheff," **HPAC Engineering**, December 1999, pp. 25-31.
7. Klassen, Kurtis J., and House, John M., "Equal Area vs. Log-Tchebycheff - Revisited," **HPAC Engineering**, March 2001, pp. 31-35.
8. Choat, Ernest, "Resolving Duct Leakage Claims," **ASHRAE Journal**, March 1999, pp. 49-53.

About the Author



Ken Kolkebeck is President of Facility Diagnostics and has spent nearly 30 years in the control field, most of it in the specialized area of controls for critical ventilation systems. For 15 years, Kolkebeck served as president of Tek-Air Systems, a company he founded that manufactures air flow and fume hood control equipment. Kolkebeck holds a BS in electrical engineering from Worcester Polytechnic Institute, Worcester, MA and has several patents awarded and pending for air flow measuring devices. He is the developer of two generations of systems for laboratory and fume hood air flow control. A past chairman of the Air Movement and Control Association's Air Flow Measurement Station Division, Kolkebeck also was a co-author and Review Committee Chairman for the ANSI/AMCA Air flow Measurement Device Test Standard 610-95. He is also a member of ISPE and ASHRAE.

Facility Diagnostics, Inc., PO Box 32, Harrington Park, NJ 07640; email - kk@facilitydiagnostics.com.

Actual Volume	Velocity Pressure	Pressure Transmitter		CFM Reading		Error in CFM	
		Low Vel. Pressure	High Vel. Pressure	Lowest	Highest	Lowest	Highest
CFM	inches wc.	inches wc.	inches wc.	CFM	CFM	%	%
2,000	0.2500	0.2475	0.2525	1,991	2,011	-0.43%	0.57%
1,000	0.0625	0.0600	0.0650	981	1,021	-1.95%	2.06%
500	0.0156	0.0131	0.0181	459	539	-8.28%	7.78%

Transmitter Range: 0-.25" wc (0-62.28 Pa) Accuracy: +/- 1% Full Scale or +/-0.0025" wc.
 Basis: One square foot duct with velocity pressure producing differential flow sensor.
 Only pressure transducer component is considered.

Figure 6. Converting pressure transducer accuracy to flow accuracy.

To overcome inherent difficulties with biopharmaceutical technology transfer, the approach to cGMP facility design and build must be integrated and flexible. Areas of change and risk must be identified, highlighted, communicated, addressed, monitored, and controlled using a skilled project team.

Transferring a Genetically Engineered Biopharmaceutical from Research to Clinical Development - Impact on Facility Design and Build Projects

by Declan Greally and Rodger Edwards

Introduction

Development of biopharmaceuticals, derived from the manipulation of biological systems, has progressed rapidly in recent years. Improved forms of insulin, new vaccines against Hepatitis B, and a whole generation of monoclonal antibodies for the treatment of cancer are among the first wave of new products. Our knowledge on the molecular biology of diseases, gained from the Human Genome Project, has led many analysts to predict a billion-dollar market for gene therapy products within the next five years.

New advances in the development of viral vectors, that is, viruses which have been genetically modified to carry therapeutic genes into the body, has moved such products closer to the marketplace. These products are being targeted against diseases such as cancer and heart disease by a number of biotech companies.

Many products are now moving from research into clinical development. This technology transfer brings with it a whole new raft of questions and uncertainties. Is the process ready

to move into clinical production? Will perceived gains now cause greater and more costly delays later? How will this move be financed? What is the required scale of operation to satisfy demand? What resources will be required? Should manufacturing take place in-house or should it be contracted out? Biotech companies, for example, are often faced with the decision to manufacture clinical material outside their own domestic territories.

The provision of suitable cGMP facilities, in a timely and cost effective manner, can be complicated by many specific technology-transfer issues. Such issues result from: (a) interpretation of regulations and regulatory pressure, (b) health, safety, environmental, and social concerns, (c) competence of the supply chain, (d) inter-organizational differences in culture, (d) shortfall in manufacturing capacity (e) skills shortage, (f) budgetary and cashflow concerns, and (g) complexity of product analysis.

Of particular importance is the commercial need for biotech companies to transfer their products out of research into clinical development as soon as possible. This, and subsequent steps, are often linked to milestone payments from investors and therefore to the very survival of the company.

Logic would dictate that one should understand fully the production process prior to the design and construction of a facility. However, the 'dash for cash' often means that this logic must be ignored and biotech companies must progress on all fronts as shown in Figure 1. Key

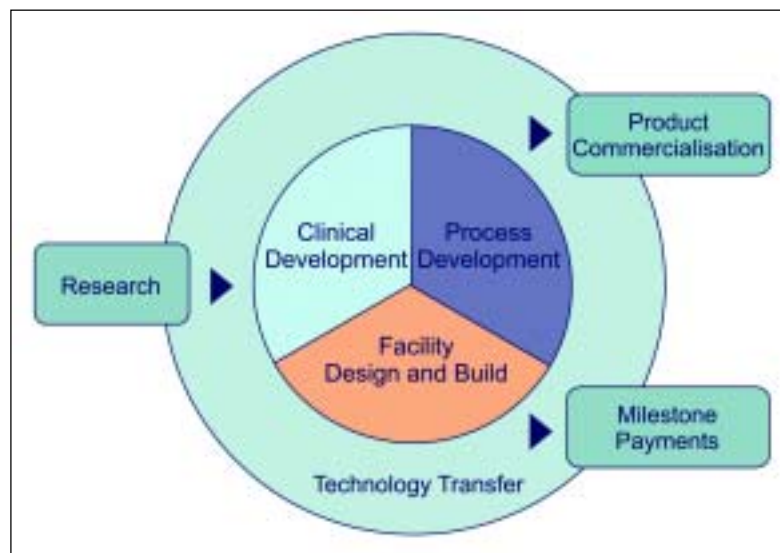

Figure 1. Moving a biotech product from research toward commercialization.

External Influences		Potential Impact on facility design
Cause	Influencing Factor	
Interpretation of pharmaceutical regulations and regulatory pressure ¹⁻²	<ul style="list-style-type: none"> - Facilities for all phases of clinical manufacture can be subjected to FDA inspection - Pressure to produce Phase III clinical material in commercial facility - Regulations constantly evolving 	<ul style="list-style-type: none"> - Increase in cost of production and capital costs for early stage clinical production - Changes in facility design to accommodate regulatory changes
Health, Safety, Environmental and Social concerns ^{3,4,5}	<ul style="list-style-type: none"> - License may be required for the handling of organisms. - Level of containment to be defined using detailed scientific justification 	<ul style="list-style-type: none"> - Containment level may change - Pressure groups may slow down progress - Design will be subject to HSE/EPA scrutiny - Changing requirements may force design change
Competence of the supply chain/Service Providers	<ul style="list-style-type: none"> - Production equipment often lab-based and not cGMP compliant. 	<ul style="list-style-type: none"> - Lab equipment may not be scalable, or suitable especially in relation to cGMP and HSE requirements - Equipment Vendors may not be able to supply cGMP compliant equipment or understand the requirements
Inter-organizational differences in culture	<ul style="list-style-type: none"> - Technology transfer between small biotech companies and medium to large pharmaceutical companies can be difficult due to cultural differences. - Equipment and methodology used in R&D may not be suitable for production 	<ul style="list-style-type: none"> - Difficult to control the R&D wish list for the facility - Lack of understanding on the need to 'freeze the process' - Big pharma companies often lack biotech experience resulting in sub-optimal design - Scale-up may involve some process change which can be difficult to evaluate and therefore slow down facility design
Shortfall in manufacturing capacity	<ul style="list-style-type: none"> - Few companies involved in the contract manufacture of viral vectors and other GMOs. 	<ul style="list-style-type: none"> - Manufacturing strategy must be developed early. High initial outlay of capital required and high risk if decision taken to manufacture in-house. Facility design occurs prior to process definition.
Skills shortage	<ul style="list-style-type: none"> - Difficult to resource projects 	<ul style="list-style-type: none"> - Poor preparation and review of key documents - Poor evaluation of cGMP and HSE requirements
Budgetary and Cashflow concerns	<ul style="list-style-type: none"> - Project 'fast-tracked' 	<ul style="list-style-type: none"> - Process still evolving therefore facility design initiated prior to process definition
Complexity of product analysis	<ul style="list-style-type: none"> - Difficult to evaluate yield, level of purity, level of contaminants etc. 	<ul style="list-style-type: none"> - Process changes to accommodate new information from analytical studies may impact facility design.

Table A. External causes and influencing factors relating to technology transfer and their subsequent impact on facility design.

decisions relating to process and facility design are therefore often taken very early in the project so that the product can get to the marketplace in the shortest possible time. Such decisions are made in the absence of development data and manufacturing process definition and can carry significant risks.

The aim of this article is to give the reader an appreciation of the issues and difficulties associated with the provision of a production facility to accommodate the transfer of a biopharmaceutical product from research into clinical development. Changes occurring within the transfer process and their impact on facility-related projects will be discussed. Ways to minimize this impact will be addressed, in particular, how to ensure that the approach to facility design and build reflects the inherent difficulties with the technology transfer of a biotech product. A case study will be used to illustrate these project-related issues and difficulties.

Issues Related to Technology Transfer

Biotech companies face many difficulties as their product makes that great leap forward from research into clinical manufacture, and service providers must respond to these challenges. Difficulties and uncertainty within the technology transfer process can lead to similar difficulties and uncertainty with respect to facility design. It is often the case that many aspects of the production process are still unknown during the design phase of the facility. An evolving production process can lead to a never-ending cycle of design changes and subse-

quently higher costs. Project teams must be able to recognize this uncertainty early in the project, know what the causes are, and know how to control it.

Table A lists some of the external influences relating to technology transfer and their subsequent impact on facility design projects. This article will discuss those factors that result in facility design changes, that is, factors which slow down the project and/or increase capital costs. In the following section, a case study will be used to illustrate these issues and subsequent learning points.

Case Study

This case study is based on the transfer of a biopharmaceutical product, from Research and Development into Phase I clinical production. New cGMP compliant facilities were required for clinical production, and issues related to the provision of this facility will be discussed below.

Process Description

Figure 2 shows that the production of this biopharmaceutical involved the use of a genetically modified virus and a genetically modified human cell line. The following paragraphs describe this particular process; however, there are a variety of techniques used to reach the same end-point, i.e. purified viral material.

Once removed from cold storage, cells were initially expanded in tissue culture flasks, roller bottles, small (seed) bioreactors, and subsequently used to inoculate the production

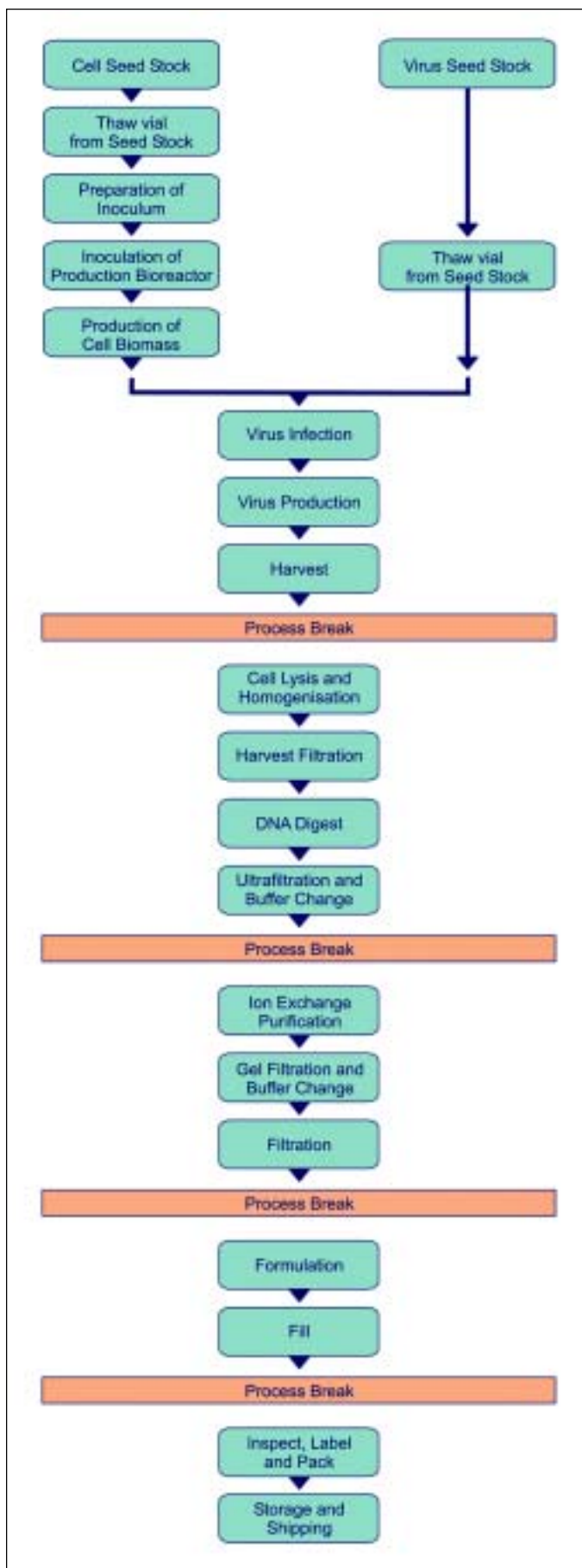

Figure 2. Process flow diagram for ViraVac.

bioreactor. When the cells reached the appropriate concentration, they were infected with virus. At peak virus production, the bioreactor material was harvested.

The harvested material was homogenized to release virus material contained within the cell. Once ruptured, cell fragments were separated from the viral product by using filtration. Cellular DNA was digested using endonucleases. Further processing involved ultrafiltration to remove contaminating macro-molecules and to carry out a buffer change. Finally, the bulk material was filtered to remove smaller particles prior to purification.

Purification was carried out using anion and cation exchange columns, followed by Gel Filtration (Size Exclusion). Formulation consisted of preparing the product in a physiological solution at the correct concentration. A stabilizer also was added to improve product shelf life without resorting to freeze-drying. Finally, the formulated bulk was sterile filtered and filled into vials under aseptic conditions in a class 100 environment.⁶

Case Study Evaluation

A decision was made to provide a new facility for this process because of the shortfall in contract manufacturing capacity. Due to tight time constraints, facility design commenced long before the process was defined and many of the technology transfer issues listed in Table A were faced by this project. These external influences impacted the technology transfer process and in turn the facility-related aspects of the project as shown in Figure 3.

The case study will be evaluated and learning points discussed in the following sections. Primary areas for discussion are:

- approach to facility design and project organization
- handling risk and change
- supply chain selection and integration into the project process

The following secondary issues also will be discussed:

- specialist skills requirements
- regulatory and social pressures
- utilities
- refurbishment of existing facilities

Evaluation of Primary Issues

a) Approach to Facility Design and Project Organization

The approach to this project, as shown in Figure 4, was conventional, highly structured, and did provide a firm foundation for the project. However, this approach meant that the project team could not respond to (or were not aware of) changes that were occurring in the technology transfer process, in particular, development of the production process. There was an over-dependence on the contractor and because of resource limitations there were insufficient documentation reviews. A detailed project URS was not developed and the Front End Engineering Study was completed prior to having many key production process details. The project subsequently moved into its next phase, Detailed Design, without first identifying and understanding gaps in information. Delays to design freeze were not reflected in the project plan which meant that timelines became unrealistic. It was assumed that time lost early in the project could be recovered later.

There was a high level of control systems and mechanical integration of process equipment. This had the tendency to reduce flexibility and resulted in high costs related to design change. Qualification of the systems also proved to be difficult and resulted in time delays.

In summary, the approach used resulted in project delays and increased costs. Furthermore, the facility was difficult to operate, resulting in process inefficiencies and higher staffing levels. Further modifications were required to the facility and equipment during the Qualification phases.

b) Risk and Change

Table B and Figure 5 show the results of an analysis that was conducted. It lists the main categories of change, the number of changes, which were authorized within each category, and the cost of those changes.

The Front End Engineering Study estimated, supposedly within a 15% level of accuracy, that the new facility would cost \$17.92 million (approx. £11.2 million) to the end of OQ. The actual cost of the project was \$24.96 million (approx. £15.6 million), an increase of \$7.04 million (approx. £4.4 million). This increase can be directly attributed to the cost of change during detailed design, construction, and qualification.

Facility and equipment design changes constituted some 50% of the total number of changes, which formed 31% of the total cost of change - *Figure 5*. This was a direct result of poor process definition and was the accepted consequence of moving forward with facility design prior to completing process development.

Of equal, or even greater, significance was the project management category, which constituted 40% (\$ 2.81 million) of the total cost of change. Changes in this category were mainly due to extensions to time required by the contractor to execute the project. These time extensions are directly attributable to changes in the other categories.

c) Supply Chain Selection and Integration of the Project Team

Vendor selection and pre-qualification was generally poor and audits were not sufficiently thorough. Process changes resulted in equipment modifications causing project delays and increased expenditure. External consultants were used to determine many aspects of equipment and facility design. There was insufficient dialogue between operators and equipment vendors, which meant that the latter were not incorporated into the project process.

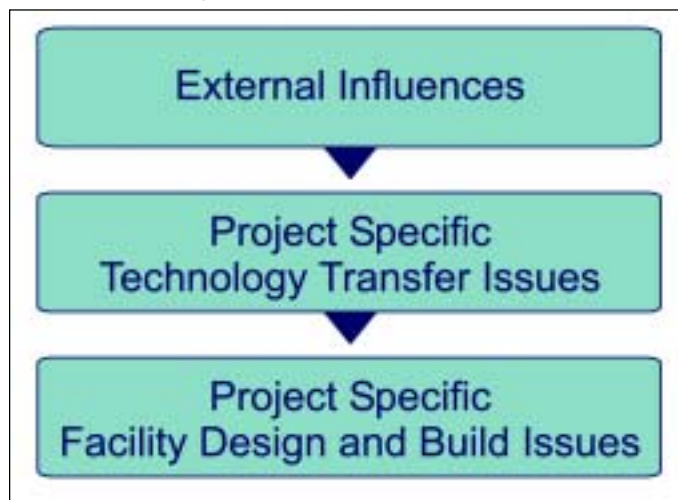

Figure 3. Impact of external influences on facility design.

Many critical requirements, especially with respect to scale, were not identified in the feasibility or front-end engineering studies; therefore, the basis for design and philosophy documents were not developed sufficiently early in the project. Preparation of URS documents also was hampered by poor process definition and resources were not available to support this activity.

The scale of manufacture required for the provision of clinical material was only two-fold greater than the scale developed in the R&D laboratory. This meant that much equipment could, in theory, simply be duplicated, thus reducing technology transfer complications. However, it transpired that many equipment suppliers were not familiar with cGMP requirements, which resulted in lengthy delays and sub-optimal equipment. Finally, airflow patterns, pressure regimes, and containment systems were not properly defined due to a lack of understanding of virus-based processes.

Evaluation of Secondary Issues

d) Key Resources

Recruitment of some key resources for the project was difficult and the recruitment activity itself was initiated very late in the project. There were inadequate resources to support the project; therefore, detailed reviews of drawings were not carried out. External consultants were used, but their scope of work was not properly defined. Such consultants often made decisions without referring back to the project team.

e) cGMP and HSE Regulatory Requirements

A number of assumptions were made early in the project with respect to cGMP and HSE regulatory requirements. Decisions based on these assumptions were made in the absence of (a) a detailed risk assessment of the biological systems used, (b) detailed discussions with the FDA and MCA, (c) accurate analytical techniques, and (d) a detailed evaluation of the existing production process. These assumptions had to be modified late in detailed design as new information emerged. This led to costly design changes and further delays. It also took longer than expected to obtain a facility license for the handling of GMOs due to the weight of public concern that needed to be taken into account.

f) Utilities

It was decided early in the project that the new production facility would draw on existing utilities such as WFI, steam, and compressed air. Utility capacity requirements for the project were calculated based on inaccurate data with respect to existing usage and future site needs. Changes in site usage over the lifetime of the project meant that there was insufficient capacity to run all facilities simultaneously.

Linking to the existing utilities ('tie-ins') caused unexpected project delays for two reasons: (a) the change control procedure required very detailed information before any engineering work could be authorized. It took longer than expected to collect this information, (b) the tie-in required a partial site shut-down, due to production pressures on site. It was difficult to schedule this, which resulted in further delays.

g) Facility Refurbishment

The provision of facilities involved the refurbishment of an existing redundant suite of cleanrooms. Assumptions made with respect to the validation status and quality of engineering for this suite proved to be incorrect. A detailed assessment and

subsequent remedial work was initiated very late in the project again resulting in unexpected costs and time delays.

Learning Points from the Case Study

Learning Point 1: Approach to Facility Design and Project Organization

It is vital for all key players from both the Steering Group and Project Team to align their objectives for the project during the initial design studies. This should be done in the form of a workshop where each person is encouraged to voice his or her opinions and concerns.⁷ If objectives are not prioritized early, individual differences may occur later resulting in project delays or additional costs. Decisions made as part of the workshop should form a sound basis for later stages of the project. All main departments must be represented in both the Steering Group and Project Team, and these representatives must be empowered to make decisions. It is equally important that the 'wish list' of each individual is checked such that cost and timelines can be controlled. It is vital that (a) lines of communication are established, (b) the decision making process is clear, and (c) ownership of different aspects of the project is assigned. This will reduce the level of uncontrolled decisions and information flow.

Poor process definition means that the supporting studies, which include the Feasibility, Conceptual, and Front End engineering studies, can underestimate the capacities required

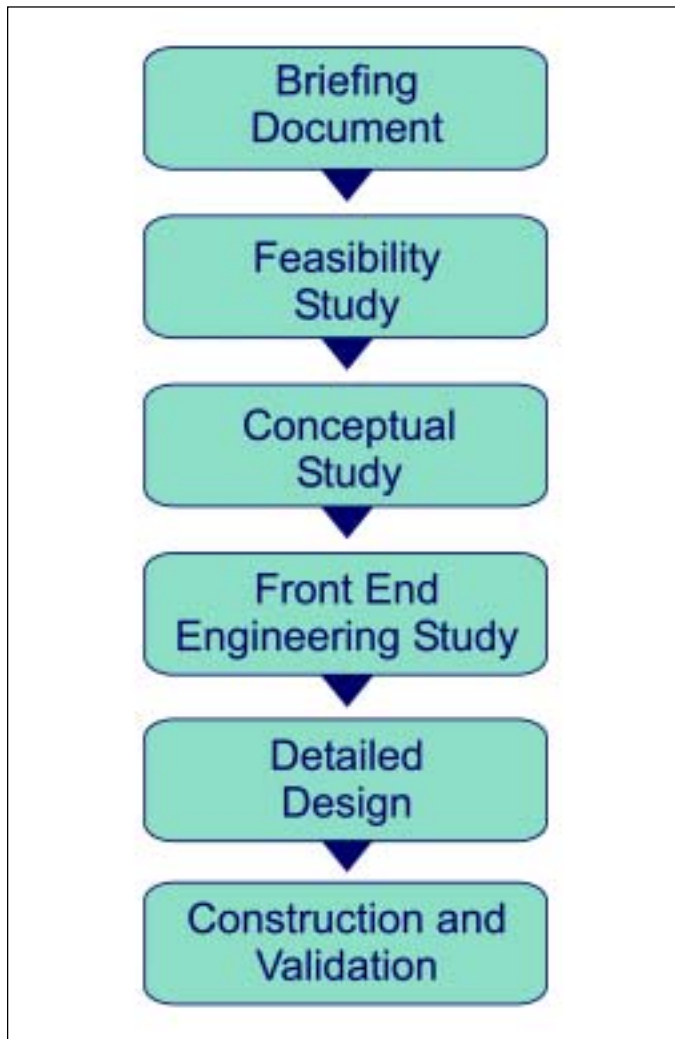

Figure 4. Approach to the project.

Project Parameter	*No of changes	*Cost of change
Facility Refurbishment	8%	3%
Facility and Equipment Design	50%	31%
cGMP and Regulatory	3%	14%
Documentation	5%	4%
Utilities	16%	5%
Project Management	7%	40%
Miscellaneous	11%	3%
*Percentage of the total of change		

Table B. Project changes within the project.

for major equipment. The Front End Engineering study should herald the facility design freeze and allow detailed design to commence. Any slippage in freezing the design and any subsequent changes must be reflected in the overall program.

Table C shows how project-related documentation could be developed and reviewed. This structure should be suitable for any biopharmaceutical facility design project; however, what will vary is the integrity of the process detail at each stage. (Note: the feasibility study is not included in this table).

Where possible, facility design should be kept as simple and as flexible as possible. Increasing the level of process equipment and control system integration will inevitably increase facility complexity. When process parameters are well known, this can be managed satisfactorily. If process development has not sufficiently evolved and process parameters are changing, integration can be very difficult and may result in numerous design changes late in the project. In these cases, 'simple is best' to ensure maximum ability to respond to change.

Learning Point 2: Handling Risk and Change

There must be an effective and efficient review mechanism available to the project team to assess both (a) the impact of potentially high risk areas or areas which are prone to change, and (b) progress in these areas. This is shown in Figure 6.

High Risk Areas are those which have the potential to impact timelines, budget, and quality of the facility (i.e., the facility may not be fit for purpose). The Risk Analysis, through a scoring process, should measure (a) the likelihood of a specific issue occurring, and (b) the likely magnitude of impact the issue could have on the project. For example, lack of key

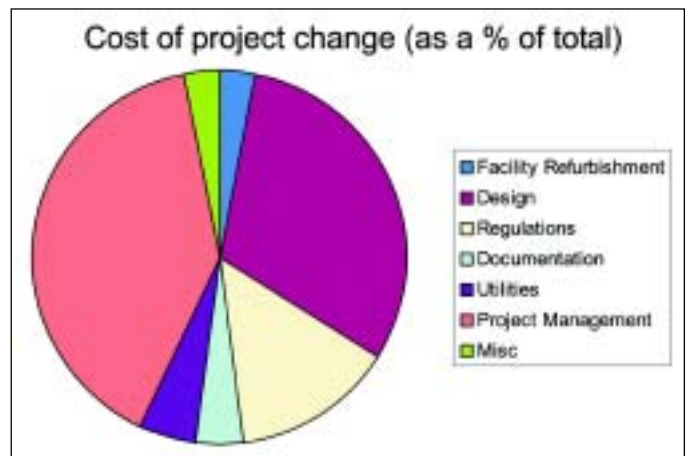

Figure 5. Cost of project change (as a % of total).

resource could be raised as an issue which (a) was likely to occur, and (b) would have a significant impact on the project. This issue, on a scale of 1 to 3, would score '3' in both cases, with a combined score of 9, moving it into the high-risk bracket.

Once selected, special attention should be given to each of the high-risk areas. Progress should be measured periodically by calculating both the percentage actions/decisions that have been carried over since the previous meeting and the percentage completed against schedule. The impact of delays should be reflected in a simplified project plan that would highlight clearly the urgency of critical decisions. It should never be assumed that time lost during one part of the project can be recovered later...this simply will not work.

Detailed project plans are not generally user friendly and top-level project plans cannot highlight individual problem areas. Most decision-makers on project teams have other responsibilities and are not dedicated to the project; therefore, problem areas and hold-ups must be presented clearly, concisely, and accurately.

In a similar way, **all** changes or proposed changes within each of the selected high-risk areas should be collated and quantified. Development scientists, in particular, must be fully aware that changes to the process at lab or pilot scale can have a significant impact on facility design. The level of change within each parameter should be presented visually and action taken if the level of change is excessive. This system will avoid incremental sometimes-uncontrolled change, which bedevils many projects. Using the Change Control procedure, changes should be monitored against the User Requirement Specification and the Front-End Engineering study. As part of this review, each change and key decision should be assessed for its likely impact on time and cost, the risks associated and the likelihood of adverse impact.

Learning Point 3: Supply Chain Selection and Integration of the Project Team

To ensure a successful outcome, the expertise and experience of contractors, equipment suppliers, and consultants involved must be clearly evident. It is important to know the combined limitations of the project team members and the supply chain. The latter must be audited so that their competencies are understood. In this way, skills can be aligned to ensure that the project process is integrated and efficient.⁸

Therefore, it should not be assumed that all vendors understand what is required from them with respect to surface finishes, testing, documentation, etc. Time should be spent up-front to ensure that all requirements are documented, talked through and agreed upon prior to placing a purchase order. Equipment vendors need to be carefully selected and monitored for any pharmaceutical project. Audits must be carried out to ensure that vendors are capable of supplying equipment to the required standard, and they should be carefully monitored during the fabrication and testing phases. URS documents must be carefully detailed especially in relation to cGMP and HSE requirements

To reduce the impact of project change means that the project structure must be adapted to suit. An integrated approach to design, build, and validation is required, and biopharmaceutical companies need to work closely with contractors and vendors. Additional resource is required to manage, monitor, and review all aspects of the project. The impact of key decisions and change requests needs to be evaluated fully using this integrated approach, and all parties involved in the project should participate in interactive planning sessions. Interactive planning sessions are excellent communication tools, and if facilitated properly, highlight all planning constraints thus avoiding unrealistic timescales.

Learning Point 4: Resources

As stated above, sufficient resources must be in place to review project documentation and decisions. It is vital that the recruitment strategy must be developed early in the project life cycle.

The project team must be comprised of a cross-section of people across the company, and all major departments must be represented. These should include Quality, Regulatory, Engineering, HS and E, Production, and R&D. The team members must be dedicated to the project and empowered to make decisions.

Apart from the normal project activities, special attention should be given to ensure that:

- a) there is specialist resource available to deal with cGMP, Regulatory, and HSE requirements
- b) all project documentation, including drawings, are prepared and thoroughly reviewed in a timely fashion
- c) equipment suppliers are selected and monitored carefully

Process requirements	Project Stage	Review activities
Outline manufacturing specification	Briefing Document	Workshop 1 to align project objectives and goals
Manufacturing Specification: (Draft)	Conceptual Study, Basis of Design, outline URS and outline VMP	Review against the Briefing document. Workshop 2 to select best option. cGMP and HAZOP reviews
Detailed Manufacturing Specification: First Issue	Front End Engineering Study Detailed Basis of Design, URS and VMP documents	Review against outline URS. Basis of design and draft VMP. cGMP and HAZOP reviews
Detailed Manufacturing Specification: Second Issue	Detailed Design	Review against the detailed URS. cGMP and HAZOP reviews
Development of Qualification test functions	Construction	Ongoing reviews against detailed design documents
Development and execution of Qualification test functions	Commissioning and Qualification	Ongoing reviews against detailed design and construction documents

Table C. Project stages showing review stages and supporting activities.

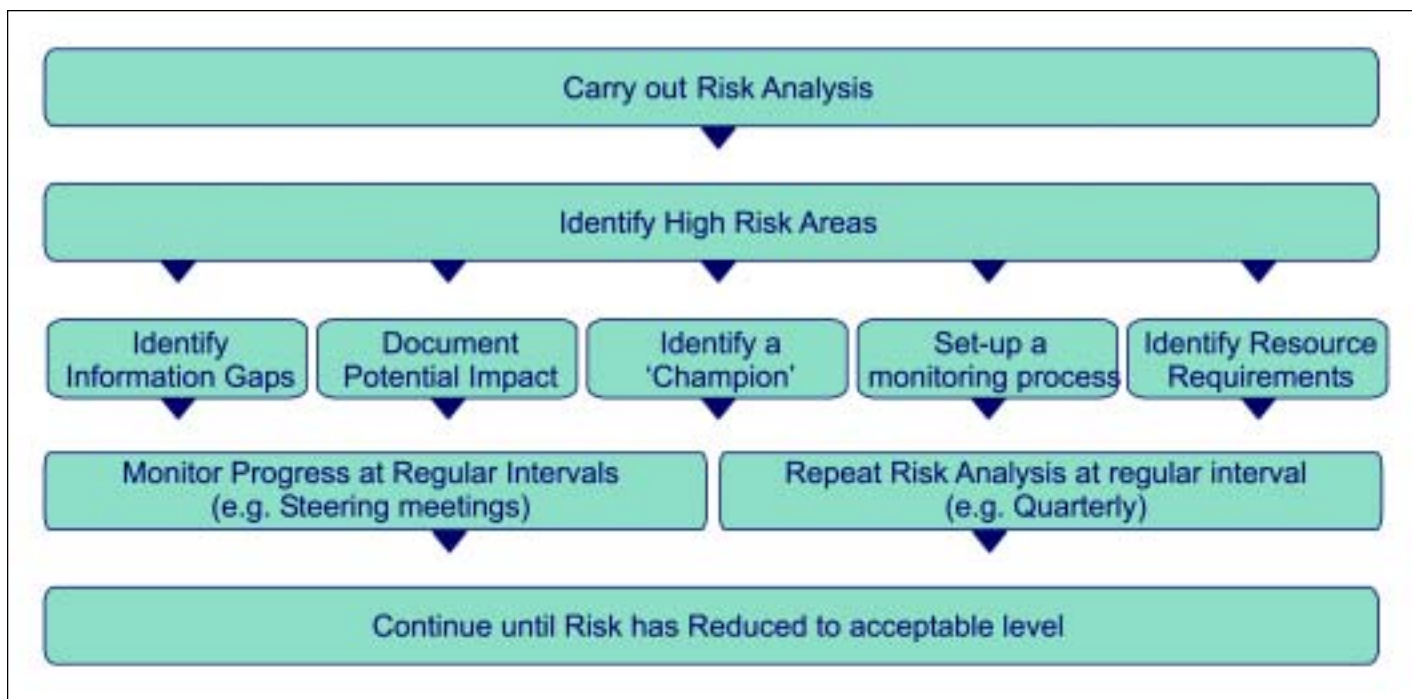

Figure 6. Handling risk.

d) changes resulting from process development and other technology transfer activities are carefully evaluated for their impact on facility design

The additional resources described will increase some aspects of the project costs; however, this must be balanced against a reduced scope of work for contractors and external consultants.

Learning Point 5: cGMP and HSE Regulatory Requirements

Moving from R&D into Clinical Development means that biotechnology companies need to source production facilities that will comply with regulatory requirements. Today, material for all clinical phases is produced in such facilities and production strategy must be developed early in the product life-cycle. Generally, there are three options open to biotech companies:

- contract out
- manufacture in-house using purpose built facilities
- collaborate with a large pharmaceutical company. Manufacture using purpose built facilities within licensed premises.

Option 'b' is generally avoided, but in all cases, expert advice is required early in the project. It must be recognized that facility design may be subject to change due to emerging regulations; therefore, as far as is practicable, potential future regulatory requirements must be taken into account and dialogue with regulatory authorities must be initiated as soon as possible.

The use of GMOs is still in its infancy and while there are numerous laboratories handling genetically modified material, there are very few large-scale facilities involved in their manufacture. Detailed risk assessments on the organisms and expert scientific input is required to determine risk to Health, Safety, and the Environment. Research scientists, for very good reasons, are often reluctant to hand over detailed descrip-

tions of the GMOs that they have developed, but this is a barrier which must be overcome so that a valid risk assessment can be carried out and to obtain a HSE/EPA license.

As with cGMP requirements, it must be recognized that expert advice is required for facility design to ensure that the correct containment requirements are part of the design. For example, many companies use modelling of air flow patterns to facilitate HVAC design. Waste handling also needs to be carefully considered to ensure that there is sufficient capacity for inactivation of effluent streams.

Society in general is still wary of any activities concerning genetically modified organisms. Publicity and staff-related issues must be carefully handled and additional security measures may be required. Staff will need to be assured that (a) they will not be exposed to dangerous biological material, (b) the facility has adequate safety measures built-in, (c) that the highest level of training will be provided, and (d) there are no potential ethical issues.

Learning Point 6: Utilities

Time should be spent weighing the choice of either a link up to existing utilities or making the facility self-sufficient. If calculations are not carried out properly, linking in to existing utilities may stress the system thus reducing quality. Process simulation tools should be used to help determine generation capacity required.⁹

Linking to site utilities also can be difficult to schedule, especially if it entails a partial site shutdown. This factor alone has the potential to delay a project significantly. Many tie-ins will result in the need to re-validate the existing system, and in some cases, prior acceptance of the change from regulatory authorities will be required. Therefore, it is vital that all pre-work documentation is in place and correct. The change control procedure should (a) trigger a detailed check of this documentation, (b) ensure that the work will be carried out properly *via* detailed method statements, and (c) ensure that the system is properly re-validated once the engineering work has been executed.

Learning Point 7: Facility Refurbishment

Refurbishment of facilities is difficult and can cost more than a total re-build. Assumptions are often made regarding the quality of existing documentation and engineering. These assumptions sometimes prove to be incorrect, and an in-depth study of the facility and its associated documentation must be carried out early in the project. This will enable the project team to (a) determine how much remedial work (including re-validation) is required, (b) how much it will cost, and (c) compare these costs against a total re-build. It is often the case that no matter how much money is spent on rectification work, the facility does not operate as required.

Conclusion

The transfer of any pharmaceutical product from research to clinical development is difficult. The transfer of biopharmaceuticals, in particular genetically engineered products, is further complicated due to many external influences such as those listed in Table A. These complications result in incremental facility design changes, which in turn lead to increased facility costs and program extensions. To overcome these difficulties, an integrated and flexible approach to design and build is required using a skilled project team.

Risk areas must be identified, highlighted, communicated, addressed, monitored, and controlled. The potential impact of change also must be fully evaluated to minimize the overall risk to the project. The adoption of a change control process early in the project life-cycle is essential and sufficient resources must be in place to manage and review all aspects of the project documentation.

Glossary

CFR	Code of Federal Regulations
cGMP	current Good Manufacturing Practice
DNA	Deoxyribonucleic Acid
EPA	Environmental Protection Agency
FDA	Food and Drug Administration
GMOs	Genetically Modified Organisms
HAZOP	Hazardous Operations
HS and E	Health Safety and Environment
HSE	Health and Safety Executive
HVAC	Heating, Ventilation and Air Conditioning
IQ	Installation Qualification
MCA	Medicines Controls Agency
OQ	Operational Qualification
PEAT MSc	Pharmaceutical Engineering Advanced Training Master of Science Degree at UMIST
R&D	Research and Development
US	United States
UMIST	University of Manchester Institute of Science and Technology
URS	User Requirement Specification
WFI	Water for Injections

References

1. U.S. Food and Drug Administration, 21 CFR Parts 210, 211, and 600.
2. Medicines Controls Agency, "Rules and Guidance for Pharmaceutical Manufacturers and Distributors 1997."
3. NIH Guidelines for Research Involving Recombinant DNA Molecules, Department of Health and Human Services, National Institutes of Health 1999.
4. Advisory Committee on Genetic Modification. ACGM News-

letter. May 7, 1999.

5. Carlson J. C., "Biowaste Systems," **Pharmaceutical Engineering**, May/June 2001, Vol 21 No 3, 70-82.
6. Greally, D, PEAT MSc, Dissertation "Facility Requirements for Biopharmaceuticals: Lessons Learned on a Design and Build and Project," pp 15 - 55.
7. Newton, A., Boorman, M., "Making Value Management Relevant to Project Delivery Teams: Some Practical Lessons Learnt," presented at the 4th European Project Management Conference, PMI Europe 2001, London UK, June 6-7.
8. Austin, S., "Design Chains - A Handbook for Integrated Collaborative Design," 2001. ISBN 0 7277 3039 8, pp 93-98.
9. Sinclair, A., England, K., "Using Simulation to Define and Minimize Capital Invested in a Biopharmaceutical Facility," IBC Biopharmaceutical Symposium Proceedings, San Diego, Nov 2001.

About the Authors



Declan Greally BSc MSc is a Pharmaceutical Specialist with Amec Ltd. He is a graduate of biotechnology from Dublin City University and has more than 16 years of industrial experience in the diagnostic and pharmaceutical industries. Greally completed his MSc in pharmaceutical engineering Advanced Training from UMIST in 1999. His experience spans from operations (mainly sterile products) in process development/production/scale-up to technology transfer of biopharmaceutical and pharmaceutical products. Technology transfer of products has involved the design/build/validation of new facilities, the preparation of production, and regulatory documentation, and finally, the recruitment and training of a production team.

Amec Ltd., Sankey House, 410 Birchwood Blvd., Warrington WA3 7WD, United Kingdom, declan.greally@amec.com.



Rodger Edwards graduated with a BSc (Honors) in metallurgy and materials science from the joint UMIST/University of Manchester Department of Metallurgy in 1979 and then spent three years as a research student in the same department, researching thermophysical properties of liquid metals. He joined the Department of Building Engineering at UMIST as a research assistant in 1983 with his main research areas being the measurement of ventilation rates using tracer gases and the computer simulation of hot water systems. He finally obtained his PhD from UMIST in 1986. In 1987, he was appointed as a lecturer in the Department of Building Engineering at UMIST, and in 1997 was promoted to Senior Lecturer. He was elected to membership of the Chartered Institution of Building Services Engineers (CIBSE) in the same year. Edwards has been the Director of the Pharmaceutical Engineering Advanced Training (PEAT) program since December 1996, and has supervised more than 40 successful MSc graduates through their dissertations. He is also a Tutor to the UMIST Graduate School, and serves on the Merseyside and North Wales Regional Committee of the CIBSE. He has been an ISPE member since 1996.

UMIST, Dept. of Building Engineering, PO Box 88, Sackville St., Manchester M60 1QD, United Kingdom.

This article describes several elements of the security planning and design process for pharmaceutical facilities, and includes some specific design considerations for today's facilities.

Security Planning and Design for Twenty-First Century Pharmaceutical Facilities

by Jeffrey Cosiol, PE and James Lindquist, PE

Security has always been a major concern for pharmaceutical facilities, and security concerns have become more prominent in response to recent worldwide incidents of terrorism.¹ This article describes several elements of the security planning and design process for pharmaceutical facilities, and includes some specific design considerations for today's facilities.

Pharmaceutical facilities of all kinds are subject to threats from a multitude of sources, including industrial espionage, animal rights groups, other activist groups opposed to specific areas of research, drug abusers, common criminals, and terrorist organizations. These threats may include life threatening acts of aggression and theft or destruction of property. Some threats, such as the removal or release of disease causing agents, could have disastrous effects. The need for security planning is clear, and has been recognized in recent guidelines published by Government agencies such as Health Canada, Office of Laboratory Security,² and Centers for Disease Control and Prevention, Office of Health and Safety.³

Pharmaceutical facility designers are concerned with providing functional and aesthetically pleasing environments. Successful facilities help to attract the best and brightest employees, and then support their efficient and productive work. Among other features, pharmaceutical facilities should provide a safe and secure environment, but the security features should not be so prominent or obtrusive as to foster a siege or fortress mentality. All employees need to be mindful of security, but successful security measures are designed to allow employees to keep their minds on their jobs.

Pharmaceutical facilities are best prepared to meet potential security threats when their owners, managers, and designers have taken stock of their security position and acted to protect their assets from credible threats. A logical, step-by-step process can be followed to improve the security posture at a pharmaceutical facility. This process can benefit new facility design projects as well as renovations of existing facilities.

Figure 1. Security Proponents on the Project Team.

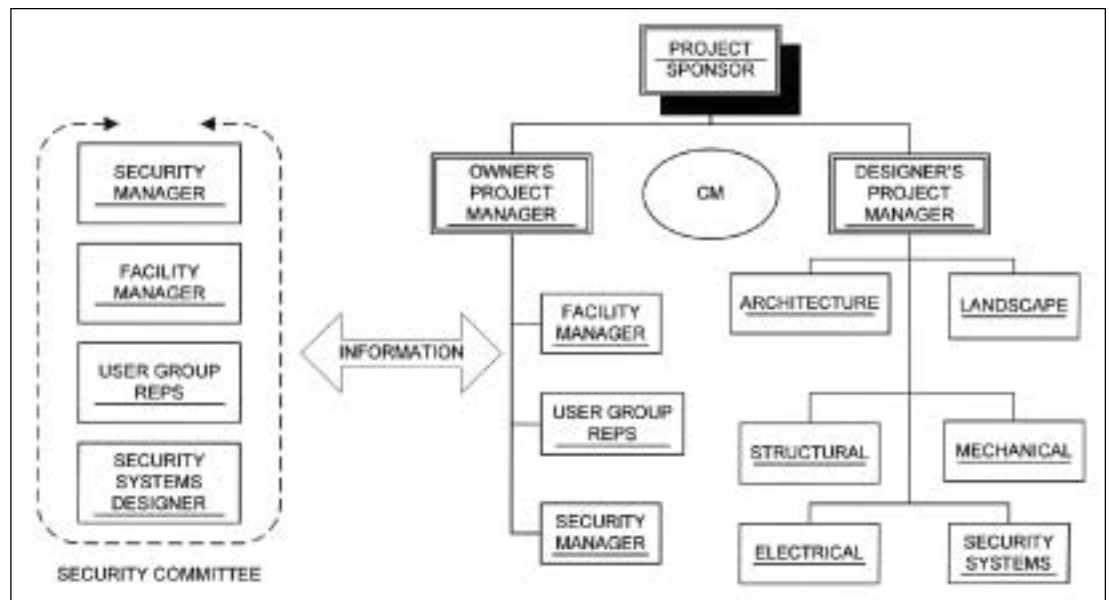



Establishing a security committee early in the life of a pharmaceutical facility project will maximize the benefit of their recommendations relative to implementation cost.



Organize for Success - The Project Team

Successful pharmaceutical facility design projects - whether new construction or renovation - consider security from project inception, and include security "proponents" on the team chart as shown in Figure 1. The best results come from consistent communication and balancing of the varying interests and viewpoints expressed by the stakeholders in a project. A "security committee," whether or not officially designated as such, should include the owner's facility management/engineering personnel and security personnel, the designer's project team members and the security systems designer, who may be an outside consultant or a qualified specialist within the design firm. The owner's facility user group representatives also must play an active role in the security planning process because they have intimate knowledge of the value of assets and operations in different areas of the facility. The facility user group is also well qualified to define requirements for personnel flow and material flow. In addition to this minimum recommended membership in the security committee, it is often helpful to have participation by the construction manager, particularly to evaluate potential budgetary impacts of alternatives.

Since the project team needs to address many diverse (and often competing) issues, the security committee should convene separately from main project team meetings to address security issues and establish security priorities, criteria, and standards for the project. Selected representatives will report results of their deliberations back to the project team for action and coordination. This interactive process is also an iterative

process; the security committee will reevaluate security criteria and standards as the design evolves, balancing opportunities and constraints established by the project team. In the final analysis, security criteria and standards, similar to other facility characteristics, will be balanced and moderated in light of budget constraints. Further details regarding the security planning and design process can be found in the March/April 1991 issue of **Pharmaceutical Engineering**.⁴ Establishing a security committee early in the life of a pharmaceutical facility project will maximize the benefit of their recommendations relative to implementation cost. The security committee will influence the following conceptual facility design issues:

- Reception Space Considerations - Is a reception area required within the building, but outside the secure envelope?
- Equipment Space Considerations - Will security panels be located in telecommunication, electrical or mechanical rooms, or will they require dedicated equipment rooms?
- Circulation Considerations - Is a dedicated circulation pathway required to access departmental areas without traversing another department's secure zones?
- Protection of Critical Utilities - Should outside ventilation air intakes be elevated to avoid possible contamination? Should critical electric switchgear be located inside the building?

Perimeter Security		
Level IV Security Elements	Recommendation	Facility Design
Parking		
Control of Facility Parking	Minimum Standard	✓
Control of Adjacent Parking	Based on Evaluation	✓
Avoid Leases Where Parking Can Not Be Controlled	Desirable	N/A
Post Signs and Arrange for Towing Unauthorized Vehicles	Minimum Standard	✓
ID System and Procedures for Authorized Parking	Minimum Standard	✓
Adequate Lighting for Parking Areas	Minimum Standard	✓
Closed Circuit Television (CCTV)		
CCTV Surveillance Cameras with Time Lapse Video Recording	Minimum Standard	✓
Post Signs Advising of 24 Hour Video Surveillance	Minimum Standard	✓
Lighting		
Lighting with Emergency Power Backup	Minimum Standard	✓
Physical Barriers		
Extend Physical Perimeter with Barriers	Based on Evaluation	✓
Parking Barriers	Based on Evaluation	✓

Table A. Security Checklist.

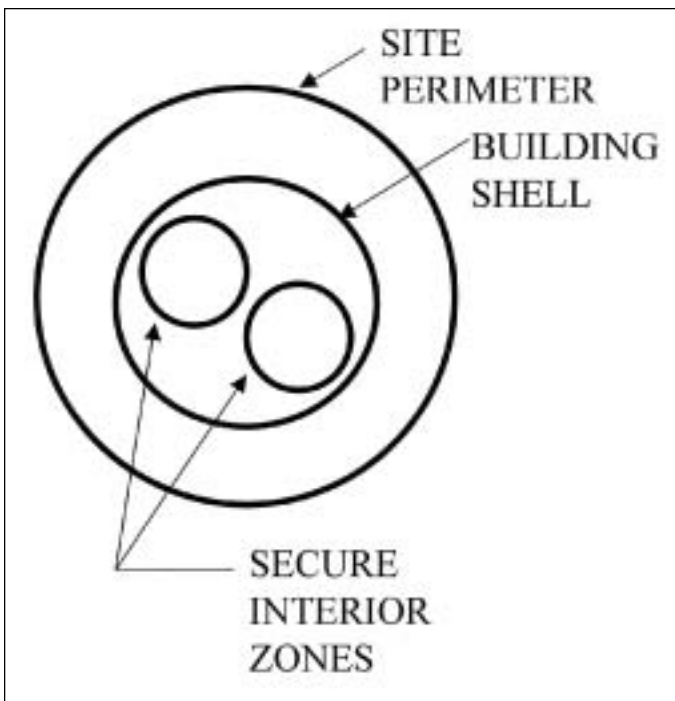

Figure 2. Concentric Rings of Security.

Follow a Systematic Approach

In response to the bombing of the Murrah Federal Building in 1995, the US Federal Government established minimum acceptable security construction and operation requirements for all Federal buildings.⁵ These requirements are applied based on the established "Security Level" of a facility, which is determined based on the building size, occupancy, mission, and degree of interface with the public. In simple terms, the minimum standards, illustrated in the checklist in Table A, depend on the security risks to which the building is exposed. In the pharmaceutical industry, for example, security requirements for a drug discovery laboratory or a drug safety evaluation laboratory will be different than corresponding requirements for an administrative office facility.

Owners, managers, and designers of pharmaceutical facilities should follow this example and use a similar systematic approach. Before designing solutions, understand the issues. A formal facility security evaluation can usually be implemented as a cooperative effort between facility managers, facility designers, and security managers with a modest commitment of time and resources. Remember that a checklist is not a panacea; security objectives must be balanced with safe egress, efficient flow, interaction, and other facility design goals. Whether or not a formal security checklist is used, the basic analytical steps in evaluating pharmaceutical facility security are as follows:

- define critical assets in your facility
- define credible threats to these assets
- evaluate potential consequences if a threat is realized
- evaluate the likelihood that the threat may be realized
- take action as appropriate to reduce likelihood or consequences

Use Security Planning Concepts - Rings, Threats and Arrows

Pharmaceutical facility managers and designers who become conversant with security design concepts will be better prepared to include security considerations in their planning. Understanding a few simple concepts also will facilitate coordination with security managers and security designers. At the same time, security designers need to use straightforward planning concepts such as these in discussing security issues with facility managers and user groups.

One of the most fundamental security concepts deals with "concentric rings" of security. These rings typically progress from the exterior boundaries of a facility site, to the exterior shell of the building, to increasingly more secure areas within the building. As shown in Figure 2, the rings of security are not always concentric - security and efficiency are often both promoted by allowing adjacent, rather than nested security zones. Each zone boundary represents increasing hardening against security threats, and the coordinated facility design will reinforce these boundaries. Each boundary creates an opportunity to deter unauthorized or undesired access to a more secure zone, to delay penetration of the barrier by a determined intruder, and to detect penetration when it occurs, allowing an appropriate security response.

Another equally important security concept, illustrated in Figure 3, deals with threats. Threats can be those organizations, individuals, or events that pose a risk to the continued safe operation of the pharmaceutical facility. The facilities manager and facilities designer should review credible threats with the security manager - credible meaning those that will be considered in developing the facility design basis. Establishing the credibility of threats can be a difficult balancing game, but the practical experience of the facilities manager and facilities designer together with the security-related knowledge of the security manager and security designer is a good starting point to find that balance. When reviewing security threats, it is tempting to look only at external threats and restrict security design considerations to "keeping the bad guy out." Protecting against internal security threats can be a thorny problem that needs to be addressed on multiple levels. From the standpoint of human resources, background checks of employees, especially those with access to sensitive areas or resources, are



Figure 3. Internal and External Threats.

Continued on page 26.

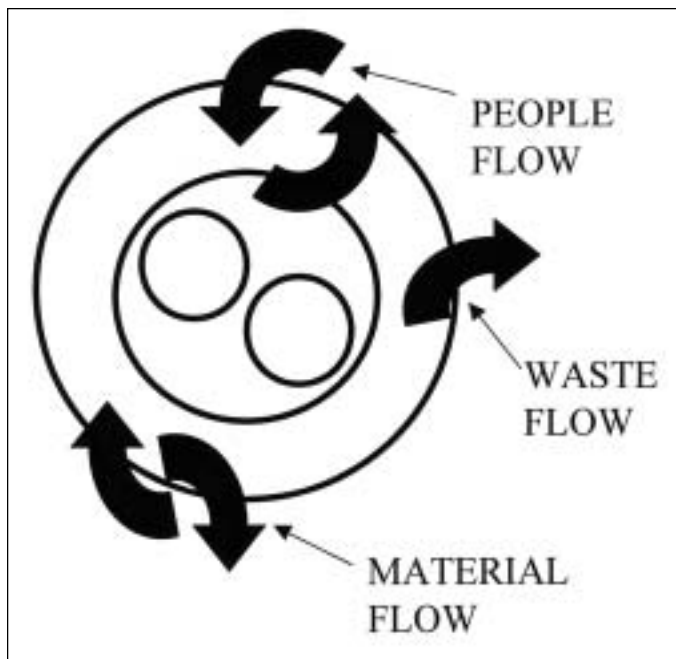

Figure 4. Arrows Representing Flows.

important.⁶ From an operations standpoint, traceability of critical data, materials, and operations is crucial. From the facility design standpoint, internal barriers between different areas of responsibility, access control systems limiting (and documenting) access to sensitive areas, and Closed Circuit (CC) TV monitoring of critical areas are useful tools to deter activities or behavior that could jeopardize the pharmaceutical firm's interests.

A third important security concept requires special attention to flows within a facility, represented by arrows as shown in Figure 4. In evaluating facility security, it is important to focus on the flow of people and materials into a facility and between different areas of a facility, and the flow of waste out of a facility, paying special attention to laboratory animals, controlled substances, and other sensitive materials encountered in pharmaceutical facilities. Flows of people, materials, and waste are key considerations in a pharmaceutical facility design project, and security is just another important angle from which to view these flows. Each time an arrow pierces one of the rings, it represents a hole in the security zone boundary, and the security committee needs to establish appropriate security goals. Is it important to prevent unauthorized vehicles from penetrating the barrier? Unauthorized personnel? Is it essential to prevent unchecked materials from entering the facility, or to prevent unauthorized removal? Once the goals are established, members of the security committee will coordinate with other team members to establish effective security measures that respect efficiency, personnel interaction, and other important facility goals.

Consider CPTED - A Broad View of Security Design

According to Timothy Crowe's book on the subject, "the proper design and effective use of the built environment can lead to a reduction in the fear and incidence of crime, and an improvement of the quality of life." This is the fundamental concept behind Crime Prevention Through Environmental Design - CPTED - a thirty-year old approach to security design. The basic concepts of CPTED are still valid today and will benefit

the pharmaceutical facility design process. There are four generally recognized CPTED concepts:⁷

Natural Surveillance

Natural surveillance is directed at keeping potential intruders easily observable. Natural surveillance is promoted by features that maximize visibility of people, parking areas, and building entrances, by configuring building entry flows so that all personnel entering a building are observed by security or operations personnel, and by adequate evening lighting. For a pharmaceutical facility, this also means building and landscape design that maintain clean sight lines and avoid potential hiding areas. Enforcement of a visible identification badge policy also will help to make unauthorized people visible. Natural surveillance will normally be complemented by CCTV surveillance, especially on pharmaceutical campuses or larger facilities.

Territorial Reinforcement

Territorial reinforcement is based on a concept that physical design can create or extend a sphere of influence. Users are encouraged to develop a sense of territorial control while intruders, perceiving this control, are discouraged. Features that define property lines and distinguish private spaces from public spaces using design elements such as landscape plantings and pavement designs promote territorial reinforcement. Signage and finish colors also are used to define boundaries. For a large pharmaceutical campus, ornamental fencing, bollards, or other physical barriers support territorial reinforcement, as do security portals where visitors are required to sign in and be escorted to their destination. Contractor and visitor parking will normally be outside the physical barriers. At some facilities, general employee parking is also outside the barriers.

Natural Access Control

Natural access control is directed at decreasing crime opportunity by denying access to crime targets and creating in intruders a perception of risk. Natural access control is promoted by designing streets, sidewalks, building entrances, and campus entrances to clearly indicate public routes, and by discouraging access to private areas with structural elements. For a pharmaceutical facility, this often means providing circulation pathways outside of secure areas and arranging spaces based on departmental or functional adjacencies. Natural access control will normally be complemented by an electronic access control system with each access-controlled door programmed to allow access only to certain individuals within defined time periods.

Target Hardening

Target hardening refers to design features that prohibit entry or access, including shatterproof glazing, door locks, and interior or tamperproof door hinges. For a pharmaceutical facility, this might include minimizing the amount of glass areas on the first floor level of a sensitive building, locating outside ventilation air intakes at a penthouse level rather than ground level, and securing critical utilities inside the building or in fenced and locked areas. A determined intruder can access even a hardened target, so security systems in pharmaceutical facilities often include intrusion detection sensors, such as door monitoring switches, motion detectors, and glass-break detectors to alert security forces to a potential breach of security.

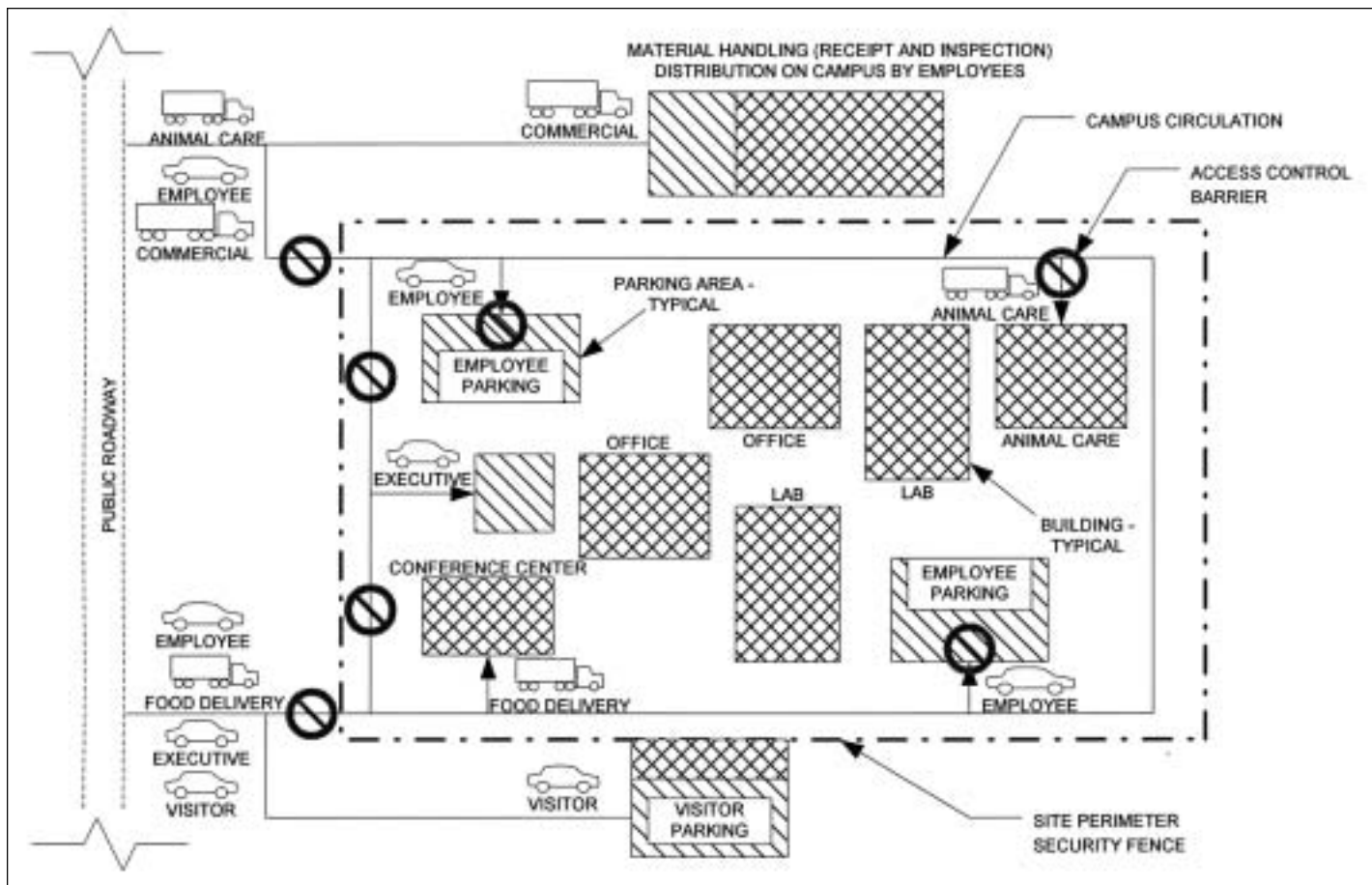

Figure 5. Vehicle Flow Diagram.

When target hardening is inadequate to deter intruders, the secondary benefit is that hardening should delay penetration long enough to permit detection, assessment, and response.

Information Security - An Unseen Threat

In today's information-intensive world, an organization's most valuable assets include information technology assets, both the electronic information itself and the systems and software used to store and process information. Many of the concepts used to deal with physical security can be successfully adapted to address information security.⁸⁻¹⁰ Both external threats and internal threats must be considered. An example of an external threat is a "hacker" trying to enter the organization's network. An example of an internal threat is an employee loading a non-business program or file onto his or her workstation from a diskette. In the first case, the threat could range from theft of information to intentional disruption of email or other services. In the second case, the threat could be unintentional infection of workstations and servers with a computer virus.

Actions an organization should consider to counter these threats include:

- installing multiple firewalls - to protect the organization's network against unauthorized intrusion and to protect specific servers
- installing virus protection software and keeping the virus signatures up to date

- software configuration requiring users to log in using a password to access a network
- establishing and enforcing a policy regarding loading of software or files from removable media or internet downloads

Develop a Security Toolbox - Not Every Problem is a Nail

There is an old saying that "To a person with a hammer, every problem looks like a nail." That saying need not apply to a skilled carpenter who has many other tools to work with, and the knowledge to apply the right tool to the job at hand. In the same way, the larger the security toolbox that pharmaceutical facility managers and designers have to work with, the easier it will be for them to find appropriate solutions to a wide range of security challenges. An assortment of tools and tips is provided below.

Parking

Three important issues to address in planning for parking security are standoff, control, and personnel safety. Standoff refers to the distance between parked vehicles and occupied facilities. The 1993 terrorist attack on the World Trade Center and the 1995 bombing in Oklahoma City highlighted risks associated with parking under or adjacent to facilities. The minimum parking standoff distance should be established based on the nature of the facility and the associated risks. This

consideration applies to parking for employees, contractors and visitors, and the security boundary between the parking area and the facility should be designed to prevent unauthorized breach by a vehicle (for example, using a guard rail or concrete-filled steel bollards). While the standoff protects the facility from certain external threats, control of vehicular access to the parking area is still important to promote safety of employees and others authorized to use the parking area. Parking control often includes a combination of a security guard (for periods of high traffic volume) and an automatic gate activated by an access control system, often supplemented by CCTV surveillance, telephone or intercom communication, and remote gate control from a security monitoring center. Gate type selection requires a balance between protection and operational convenience. Where these requirements collide, the balance can sometimes be achieved by selecting a semaphore-type gate (for normal operating hours) backed up by a higher-security (but normally-open) sliding gate to be closed during off-hours.

Additional measures to enhance the safety of employees in parking areas include providing adequate lighting and emergency voice communication to a security-monitoring center. Emergency communication can be provided by emergency call boxes, which typically provide a duress alarm button and a hands-free intercom or telephone. Effective response to an alarm from an emergency call box is facilitated by CCTV coverage. A fixed camera can be provided to view each emergency call box. As an alternative if pan-tilt-zoom cameras are used for general parking area surveillance, activation of the duress button could signal the CCTV control system to position

the pan-tilt-zoom camera to view the emergency call box that is in alarm.

Recent advances in CCTV camera technology have greatly improved the effectiveness of CCTV surveillance in parking areas and similar locations subject to large variations in lighting levels. In the recent past, most outdoor CCTV applications used black-and-white cameras because color cameras had poor low-light sensitivity. The advent of the day-night switching camera provides the advantages of color video when lighting conditions are appropriate. This allows security personnel to distinguish the color of a vehicle or an individual's clothing, for example. When lighting conditions are inadequate for full color video, the camera automatically switches to black-and-white mode, providing increased sensitivity and greater image clarity.

Vehicle Access

Vehicle access to the pharmaceutical facility or site should normally be restricted to pre-arranged, authorized deliveries or service vehicles (of course, planning must allow access for emergency vehicles such as ambulance and fire-fighting equipment). Clearing a vehicle for entry to the site requires either a stationary security guard at a controlled site entrance, or a remotely controlled gate with CCTV surveillance and telephone or intercom communication to a security-monitoring center. The advantage of a stationary security guard, at least during anticipated peak traffic periods, is the ability to physically inspect the vehicle before providing access. During off-peak hours, a roving security guard could be dispatched to inspect the vehicle and grant access. The importance of physiees

“

Whatever types of access control devices are used, one of the most important design considerations is safe egress.

”

cally inspecting the vehicle may depend on how critical the facility is to the pharmaceutical firm's business. If vehicles are admitted based on remote visual and verbal communication, procedures should be established to deny entry to vehicles that do not have confirmed business at the facility.

Requirements for vehicle access to a pharmaceutical facility can be routine, such as mail or express package delivery, basic maintenance such as a repair electrician or other contractor, or highly sensitive in the case of delivery of laboratory animals to a quarantine area. Layout of access roadways and signage should be clear to avoid problems or (at least) disruption that could result from the repair contractor arriving at an animal loading dock, or an animal delivery arriving at the general loading dock. When a site contains multiple types of facilities, it is sometimes appropriate to provide a secondary vehicle access control point between the circulation roadway and an animal research facility or other sensitive facility, to prevent unauthorized access, and to make sure that the appropriate receiving managers are available to control receipt of authorized deliveries. Site traffic planning is aided by use of a vehicle flow diagram as shown in Figure 5.

Mail delivery and handling, which were once considered completely routine, have received increasing scrutiny because

of the potential for explosive devices or disease-causing agents to be delivered through the mail. One response to this threat is to have a single mail receiving and handling area, adjacent to a delivery dock and segregated from the rest of the facility to check and sort mail for internal delivery. If the security goals for the facility include protection against the spread of disease-causing agents received through the mail, a mail handling area within a building should have floor-to-structure partitions and a separate air handling system, which may have special-purpose filtration.

Access Control

A primary internal security consideration for a pharmaceutical facility is access control. Access control can be provided through lock and key or through a card access system. A card access system uses an encoded access card instead of a key (or a key ring full of keys). A centralized card access system provides many advantages over the use of keys, for example, it can be imprinted with an individual's photograph and additional information to double as an identification badge, it is operationally more convenient (especially for doors requiring frequent access), and the access control system provides an electronic record of who entered an area at what time. Many

with requirements to access multiple facilities can do so with a single card. The operational efficiencies are even greater when the facilities are networked together and a centralized card access system database is maintained. The database information is transmitted to the card access controllers in each building so that access decisions are made locally, but the cost of administration is reduced because data input is centralized. Access to highly sensitive or critical areas, for example the animal holding suites in an animal research laboratory, may require an authorized access card plus an additional credential to prevent access by an unauthorized individual using a stolen card. A common secondary credential is manual entry of a Personal Identification Number (PIN), similar to using an automated teller machine. For the most critical or sensitive areas, which might include controlled substance storage areas or infectious disease suites, some facilities now use biometric readers (such as hand geometry readers) that automatically check a person's physical characteristics for stand-alone access control or to confirm a match with the presented access card.

Whatever types of access control devices are used, one of the most important design considerations is safe egress. Most building codes prohibit locking doors in a required path of egress, and the design team needs to coordinate personnel access and egress paths to accommodate this requirement. When requirements of security and free egress conflict, some Building Codes permit (in some building occupancy types) a special locking arrangement referred to as a delayed egress device. Delayed egress devices meeting requirements of Building Codes are available from several manufacturers.

Detection and Alarming

Many facility design features enhance security by deterring an intruder or unauthorized person from attempting to breach a security boundary, or by delaying the breach. However, deterrence and delay are not sufficient when an individual is purposefully attempting to breach security and is determined to succeed, despite the difficulty. To reduce the risk of unauthorized access to pharmaceutical facilities, most facility designs include electronic security systems to detect real or threatened security breaches, alarm their occurrence, and facilitate assessment of the alarm.

For most pharmaceutical facilities, detection starts at the building envelope. As one might expect, the main focus of detection is at potential "holes" in the envelope - primarily doors and windows. The magnetic door-monitoring switch is the most common method of detecting unauthorized access to a building. This consists of a reed switch in or on the doorframe that is activated by a magnet attached to the door itself. These devices are normally concealed for aesthetic reasons and protection from tampering although surface mounted versions are available for retrofit applications and for more "industrial" applications such as coiling or roll-up doors at loading docks. Door monitoring switches are used on doors with card access controls to alarm a door opening without a valid card read or request-to-exit and to alarm a door propped-open condition; on emergency egress-only doors to alarm any opening; and on normal entry or passage doors during off-hours periods to alarm abnormal activity.

In addition to door monitoring, many facilities with glass at the ground level (or for some facilities, reachable with a ladder) use glass break detection in the spaces with exterior glazing. Unlike the "shock sensors" applied directly to the windows in some retail storefront applications, most glass break detection

in pharmaceutical facilities uses ceiling mounted acoustical detectors that are designed to respond to the acoustic energy pattern associated with breaking glass. These devices are typically more economical than shock sensors in large areas because a single sensor can cover a large expanse of glass. The selection and layout of these devices must be carefully evaluated, particularly if glass is hardened by the installation of armored film for ballistic or shatter protection. The application of film to the glass alters the acoustic energy and requires a larger number of sensors than glass without film. Another condition that would have a major impact on the performance of ceiling mounted acoustical glass break detectors is the presence of heavy window treatments.

Further intrusion detection may be provided in specific, limited-access spaces by using motion detectors. One of the most common types of motion detectors is the passive infrared or PIR sensor. The PIR sensor detects the thermal energy of a person moving through the field of detection. Sensors with many different detection patterns are available from a number of manufacturers, and the type and arrangement must be carefully coordinated based on the desired field of detection and the space type and geometry. It is generally not practical to blanket a facility with motion detectors, so these devices are often reserved for the most critical spaces such as controlled substances storage. Another effective use is to provide motion detectors at major intersections and in stairwells to alarm unexpected off-hours traffic. One important caution is to avoid mounting PIR sensors in a location where direct sunlight will fall on them.

Intrusion detection alarms are annunciated at a security monitoring workstation (a PC workstation with special-purpose software). Alarms can be displayed as text messages although many systems available today have the capability to display alarms as graphic icons on floor plan backgrounds. A primary workstation will typically be provided in a security-monitoring center, while networking technology permits duplication of all alarm information at a secondary command and control point.

As the next step, security procedures must address the response to an alarm. Some assets are so critical to a pharmaceutical firm's business that an associated alarm will always require immediate on-site response by security officers. However, more immediate, and certainly more efficient, alarm assessment is facilitated by the use of CCTV.

CCTV Surveillance

CCTV surveillance is frequently used in pharmaceutical facilities as a deterrent to individuals who might consider violating security procedures. When coupled with intrusion detection alarm devices such as door switches, motion detectors, or glass-break detectors, CCTV can be used effectively for alarm assessment. An interface between the security alarm monitoring system and the CCTV control system will permit immediate display and recording of the associated camera scenes when an alarm is activated. Some of the newer technology cameras and camera control systems can provide video motion detection, providing both alarm and assessment functions.

Another important use of CCTV is for historical investigation when a security breach has been discovered. Traditional CCTV recording uses videocassette recorders (VCRs) and magnetic tapes, which must be changed on a daily schedule, marked and stored for a time period determined by the security manager, and then rotated back into use. Some of the draw

backs of the magnetic tape are cost, storage space requirements, VCR maintenance costs, and tape degradation after several uses. New technology digital video recording systems address some of these drawbacks by storing CCTV images in digital format on a computer hard drive with periodic archiving to digital audio tapes or similar magnetic media (at a higher cost than traditional VCRs). Taking advantage of recent computer technology development, video archiving can now use recordable DVDs, providing even greater convenience with the promise of lower prices as the technology matures.

Security Response Planning

Security planning elements discussed to this point have focused on deterring threats to security, delaying their execution, detecting intruders, and assessing the situation after a security alarm is activated. The glue that holds this security framework together consists of planning to establish responses to a spectrum of threat scenarios, and employee training to respond rapidly and safely under stress. Facility operations managers should establish relationships with local emergency response agencies (police, fire, and medical) as well as regional and national law enforcement agencies to obtain their input to response plans. The cooperative planning efforts should include agreements for exchange of information regarding threats and risks. Security force response plans must include notification of authorities when criminal activity is suspected or safety is endangered. All employees should be trained on what to do in the event of security violations, from an email virus, to missing documents or materials, to situations requiring evacuation of a building or movement to an agreed assembly point. Some key employees may be trained in the use of hidden egress routes to quickly remove individuals from an area of potential conflict.

A key element in responding to a security event is emergency employee communication. Trained security personnel must have access to communication systems from their primary command and control point (typically the security monitoring center). An alternate command and control point should be available in case of evacuation of the primary location. Public address and voice evacuation systems can be supplemented by a system of key individuals (area or department coordinators) entrusted to quickly and reliably communicate important information to others in their area of responsibility.

Summary

Effective security planning and design for pharmaceutical facilities requires people, organization, communication, logical procedures, and sound concepts and tools. In order to provide the greatest benefit, security considerations should be addressed early in the project life cycle. The benefits of effective security planning and design can include a safe and secure workplace, operational efficiency, and positive perceptions of facility quality.

References

1. Higginbotham, J. (ed.) and Rozgus, A., "Labs Rethink Security" and "Bringing Security to an Insecure Lab World," **R&D Magazine**, November 2001.
2. **The Laboratory Biosafety Guidelines, 3rd Ed. Draft**, Health Canada Office of Laboratory Security, September 20, 2001.

3. **Biosafety in Microbiological and Biomedical Laboratories, 4th Ed.**, Center for Disease Control and Prevention, Office of Health and Safety, April 1999.
4. Cosiol, J., "Security Planning and Design for Pharmaceutical Facilities," **Pharmaceutical Engineering**, Vol. 11, No. 2, March/April 1991.
5. **Vulnerability Assessment of Federal Facilities**, U.S. Department of Justice, United States Marshals Service, 1995.
6. Davis, Ann, "Employers Dig Deep into Workers' Pasts, Citing Terrorism Fears," **The Wall Street Journal**, March 12, 2002, Page 1.
7. Crowe, Timothy D., (2000) **Crime Prevention Through Environmental Design: Applications of Architectural Design and Space Management Concepts**, Butterworth: Stoneham, MA.
8. Benson, Christopher, **Best Practices for Enterprise Security - Security Threats, Security Strategies, and Security Planning**, on-line at www.microsoft.com/technet/security/bestprac.
9. Wack, John, **Guidelines on Firewalls and Firewall Policy**, National Institute of Standards and Technology, ITL Bulletin January 2002.
10. Hash, Joan S., **Risk Management Guidance for Information Technology Systems**, National Institute of Standards and Technology, ITL Bulletin January 2002.

About the Authors



Jeffrey Cosiol, PE, earned his BS in electrical engineering from Lowell Technological Institute and MS in electrical engineering from Drexel University. He is currently the Managing Principal for Engineering Consulting Services at Kling Lindquist. During his 25 years with the firm, Cosiol has become a recognized expert in the design and implementation of voice and data communication systems, computer-based security, energy management systems, and automation systems for commercial, industrial, and institutional facilities. Cosiol is a member of the Society of Military Engineers, the American Society for Industrial Security, the Association of Energy Engineers, and the Association of Physical Plant Administrators.



James R. Lindquist, Director of Electrical Services, earned his BS in engineering from Swarthmore College, and MS in engineering management from Drexel University. During his 17 years with Kling Lindquist, he has held the positions of project instrumentation engineer, project manager, and chief instrumentation engineer, and is currently Principal and Director of Electrical Services, responsible for power, automation, telecommunications, fire alarm and security systems designs.

Kling Lindquist, 2301 Chestnut St., Philadelphia, PA 19301. www.kling.us.